

# Keysight Technologies Lightwave Catalog

## 2018 Test & Measurement Networks and Data Centers



Keysight M8040A 64 GBaud High-Performance BERT

- Bit Error Ratio Tester (BERT)
- Digital Communication Analyzer (DCA)
- Tunable Laser Source (TLS)
- Optical Power Meter
- Wavelength Meter
- Optical Attenuator and Switch
- Polarization and PER Analyzer
- Optical Modulation Analyzer (OMA)
- Lightwave Component Analyzer (LCA)
- Arbitrary Waveform Generator (AWG)
- Oscilloscope
- Digital Interconnect Test System (PLTS)
- Application Briefs
- Application Software





## Introduction by Dr. Joachim Peerlings

### Keysight in Digital and Photonic Test



The technical world is changing faster than ever before. Big data analytics and machine learning technology provide new insights into processes and optimization in all industries.

Tremendous search capability in text, voice, images and video is opening new facets in our private lives.

Businesses get access to unlimited computing, video streaming and server power in the cloud at moderate cost, helping to speed returns.

This all is made possible through a huge communication network based on hyperscale data centers, long-distance and metro transport networks, but also a more and more refined wireline and wireless access network.

The underlying technology is based on:

- 100G and 400G optical transceivers for the client and line sides
- high speed interconnects at backplanes
- high speed interfaces between CPU and accelerators like FPGA and GPUs
- integrated optics (silicon photonics) for high density and energy efficiency

In the meantime, the brightest engineers are preparing the ground for 2020, when we expect billions of IoT devices (Internet of Things), Industry 4.0, autonomous cars, personal robots and assistants. This further challenges the network and needs creative thinking and smart solutions.

Engineers need a partner in test and measurement who can accompany each step in tackling these upcoming challenges.

Keysight is your T&M partner, offering solutions along the entire value chain, from component development to network equipment, of the communication network, addressing the latest technologies like silicon photonics, 400G PAM4 and coherent transmission.

Keysight supports your needs in research and development with high speed digital solutions for transmitter and receiver testing, but also for design and cost-effective manufacturing of quality optical components and modules.

Let me emphasize five product and solution innovations, which might be of interest to you.

#### N1076B/78A Clock Recovery up to 64 GBaud

Accurate clock recovery solutions for high-speed applications up to 64 GBaud supporting NRZ and PAM4 signals.

#### M8040A 64 Gbaud High-Performance BERT

The Keysight M8040A is a highly integrated BERT for physical layer characterization and compliance testing. It supports PAM-4 and NRZ signals and data rates up to 64 Gbaud covering all flavors of 200 and 400 GbE standards. The M8040A BERT offers true error analysis and provides repeatable and accurate results, optimizing the performance margins of your devices.

#### N109X DCA-M Optical/Electrical Sampling Oscilloscopes

For years engineers have trusted the DCA to provide accurate and easy measurement of digital communication waveforms. The Keysight N109X DCA-M family has built on that legacy by using the high-performance elements of both the 86100 oscilloscope mainframe acquisition system and the optical and electrical channel hardware of the 861XX plug-in modules. The N1090A supports 1 to 10 Gb/s measurements, while the N1092A and N1094A are for use from 26 to 53 Gbd.

#### M8290A Optical Modulation Analyzer and High-speed Digitizer Test Solution

The M8290A is a flexible solution platform for 400G coherent devices and transmitter test. It incorporates a 92 GSa/s modular optical modulation analyzer and a 92 GSa/s 4-channel electrical digitizer. Besides these modules an additional arbitrary waveform generator module up to 92 GSa/s, such as the M8196A, can be added to the same AXIe chassis.

#### The Digital Interconnect Test System PLTS 2018

The Digital Interconnect Test System PLTS 2018 is based on a VNA or TDR and has advanced signal integrity features for analyzing cables, connectors, PCBs and backplanes. Multi-domain analysis allows time, frequency, PAM-4 eye diagrams, RLCG, pre-emphasis, equalization, and channel operating margin figures of merit. A user friendly interface provides complex measurements with simple wizards including automatic fixture removal.

Enjoy skimming through and referencing the new expanded 120-page Keysight Lightwave Catalog.

**Sincerely, Dr. Joachim Peerlings**

Vice President and General Manager  
Networks and Data Centers

# Table of Contents

<b>Introduction &amp; New Product Announcements</b>	
Introduction by Dr. Joachim Peerlings	03
<b>Application Briefs</b>	
81606A Tunable Laser Source – a Look Inside	06
Optical Transient Measurements	08
Swept-Wavelength Optical Measurement Solutions	09
Wavelength and Polarization Characterization of Optical-to-Electrical Components	10
All-states Method for PDL and PER	11
Choosing a Detector for Power Measurement of 850 nm Signals	12
Wavelength and Polarization Dependence of 100G-LR4 Components	14
Optical Receiver Stress Test	16
Optical Modulation Analysis Tools	19
Coherent Transmitter and Modulator Test	20
Research on Modulation Formats	21
Impairments in Complex Modulation Transmission	22
400G Reference Coherent Transmitter and Coherent Receiver	24
Integrated Coherent Receiver (ICR) Test	25
Coherent Optical Transmit & Receive Devices Test	28
Optimizing Manufacturing Test Cost	30
Testing Transceivers Used in Fiber Channel Networks	31
Communications Waveform Measurements	32
Why is Physical Layer Testing Required? (PLTS 2018)	34
Lightwave Component Analysis	38
<b>Application Software</b>	
N7700A Photonic Application Suite	39
<b>Tunable Laser Sources (TLS) &amp; Fixed Sources (DFB &amp; FP)</b>	
81600B, 81602A, 81606A, 81607A, 81608A, 81609A Tunable Laser Modules	40
81950A, N7711A and N7714A Compact Tunable Laser Sources	42
81663A DFB Laser Module and 8165xA Fabry-Perot Laser Modules	45
<b>Optical Power Meter</b>	
N7744A and N7745A Optical Multiport Power Meter	47
N7747A and N7748A High Sensitivity Optical Power Meter	48
8163xA/B and 8162xB Optical Power Meters	49
81610A and 81613A Return Loss Modules	53
<b>Polarization Products</b>	
N7781B Polarization Analyzer	54
N7782B PER Analyzer and N7783B Thermal Cycling Unit	55
N7784B, N7785B, N7786B Polarization Controllers	57
8169A Polarization Controller	59
N7788B Optical Component Analyzer	60
<b>Multi-Wavelength Meter</b>	
86120D and 86122C Multi-Wavelength Meters	62
<b>Optical Attenuator &amp; Optical Switches</b>	
8157xA High-Power Optical Attenuators	64
N775xA and N776xA Multi-Channel Optical Attenuators	66
81595B, N7731A and N7734A Optical Switch	68

## Table of Contents (cont.)

<b>Lightwave Component Analyzer (LCA)</b>	
N4373E Lightwave Component Analyzer (Single-Mode)	69
N4374B Lightwave Component Analyzer (Single-Mode)	70
N4375D Lightwave Component Analyzer (Single-Mode)	71
N4376D Lightwave Component Analyzer (Multimode)	72
<b>Optical Modulation Analyzer (OMA) &amp; ICR Test</b>	
M8290A Optical Modulation Analyzer and High-speed Digitizer Test Solution	73
N4391A Optical Modulation Analyzer	74
Infiniium Z-Series Oscilloscopes (part of N4391A systems)	75
N4392A Portable Optical Modulation Analyzer	76
Optical Modulation Analyzer Selection Table	78
<b>Oscilloscopes &amp; O/E Converter</b>	
N7004A Optical-to-Electrical Converter	79
Infiniium V-Series Oscilloscopes (8 to 33 GHz)	80
<b>Arbitrary Waveform Generator (AWG)</b>	
M8190A 12 GSa/s Arbitrary Waveform Generator (AWG)	81
M8195A 65 GSa/s Arbitrary Waveform Generator (AWG)	84
M8196A 92 GSa/s Arbitrary Waveform Generator (AWG)	85
<b>Bit Error Ratio Tester (BERT)</b>	
J-BERT M8020A High-Performance BERT	86
M8062A 32Gb/s BERT Front End	87
M8040A 64 Gbaud High-Performance BERT	88
N4960A Serial BERT 32 and 17 Gb/s	89
N4980A Multi-Instrument BERT Software	92
<b>Digital Interconnect Test System</b>	
Digital Interconnect Test System PLTS 2018	93
<b>Optical Receiver Stress Test (ORST)</b>	
Optical Receiver Stress Test Solution	94
81490A Reference Transmitter	97
<b>Digital Communication Analyzer (DCA)</b>	
N1076B, N1077A and N1078A CDR Solutions	98
N109X DCA-M Optical and Electrical Sampling Oscilloscopes	99
N1090A, N1092A/B/C/D/E and N1094A/B DCA-M Configurations	101
86100D Wide-Bandwidth Oscilloscope	102
86108B Precision Waveform Analyzer	109
<b>SMUs</b>	
B2901A/02A/11A/12A Precision Source/Measure Unit (SMU)	110
B2961A/B2962A 6.5 Digit Low Noise Power Source	111
LIV Test of Laser Diode Using the B2900A Series of SMUs	112
B2900A Series of SMUs comes with a Range of free Software Options	113
Quick I/V Measurement Software and EasyEXPERT Group+	114
<b>Selection Tables &amp; Accessories</b>	
Accessories	115
Sometimes, Innovation is in the Smallest Part	117
Optical Power Meter Selection Table	118
Tunable Laser Source Selection Table	119
BERT Selection Table	120
Optical Modulation Analyzer Selection Table	121
Oscilloscope Selection Table	122

## 81606A Tunable Laser Source - a Look Inside

[www.keysight.com/find/81606](http://www.keysight.com/find/81606)

The new 81606A is the top of our tunable laser family, with a new level of performance for rapid wavelength dependent measurements.



- More than 10 mW signal power with even lower spontaneous emission background
- Better wavelength accuracy, repeatability and resolution at all sweep speeds
- Faster maximum sweep speed and shorter acceleration zones at sweep endpoints
- Bidirectional measurement sweeps

For results in practice, this brings:

- The widest dynamic range for measuring the spectral transmission of wavelength-selective components, especially combined with Keysight optical power meters and software
- Extreme accuracy and repeatability on both wavelength and power scales for confidence in spectral test tolerance limits
- The ability to repeat such measurements at a high rate, even over a wide wavelength range, for real-time feedback in adjustment and calibration procedures

### Key Performance Features

- Wavelength: 1450-1650 or 1490-1640nm
- Sweep speeds: up to 200 nm/s
- typ. max. power: >12 dBm peak
- typ. signal to SSE ratio:  $\geq 80$  dB/nm
- typ.  $\lambda$  accuracy:  $\pm 2$  pm static,  $\pm 3$  pm sweeping

### A new cavity design makes it possible

The 81606A is built around a new cavity design for improved spectral purity: lower SSE, lower SMSR at higher output power.

The drive unit has been redesigned for better acceleration and sweep linearity which makes it the ideal actor for the laser's closed-loop tuning control.

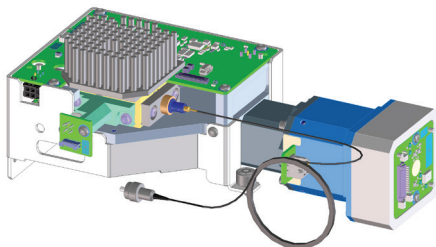

The multi-axis dynamic control during sweeps and the resulting wavelength accuracy, and power and mode stability are supported by a new high-bandwidth wavelength monitor including a gas-cell reference. The mechanical drive is also further developed for high speed sweep control, fast acceleration and qualified for long life.

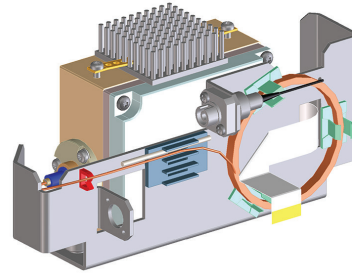

The novel wavelength reference unit

### A new laser module design

The redesigned laser module contains a new, higher-output gain chip and a novel beam splitter for lower SSE. A monitor provides additional feedback for the active tuning control loop.

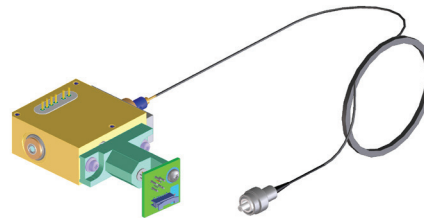

### 15 dB more dynamic range

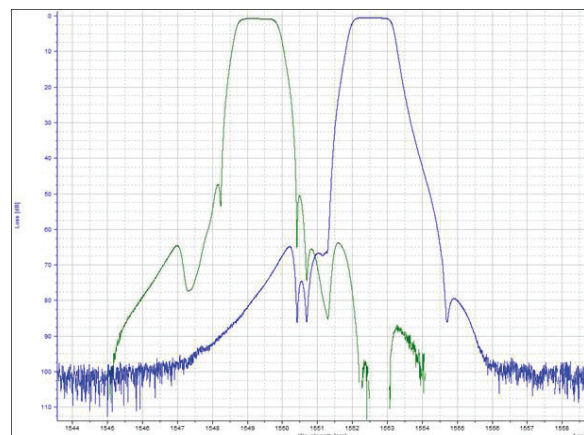

2 channels of a DWDM demultiplexer measured with the N7747A high-sensitivity power meter at 50 nm/s: low SSE and high-sensitivity linear detectors uncover filter details to 100 dB dynamic range. The low total SSE benefits notch filter and interleaver measurements, showing depths beyond 70 dB.

[www.keysight.com/find/81606](http://www.keysight.com/find/81606)

Our innovative technology is supported by the mature experience and continuous research in our calibration and test procedures, which allow a statistically solid and traceable basis for confidence in our published specifications.

### Keysight 81606A - Designed for Best Accuracy

While static wavelength accuracy can be verified with a wavelength meter, that isn't enough to confirm the dynamic accuracy during a sweep. As an illustration of the dynamic accuracy achieved by the laser with its internal reference unit, these figures show the offset of spectral lines, when measured at full 200 nm/s speed with 0.5pm resolution.

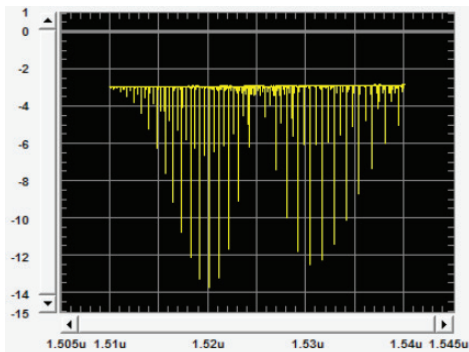

Absorption lines of a C2H2 gas cell

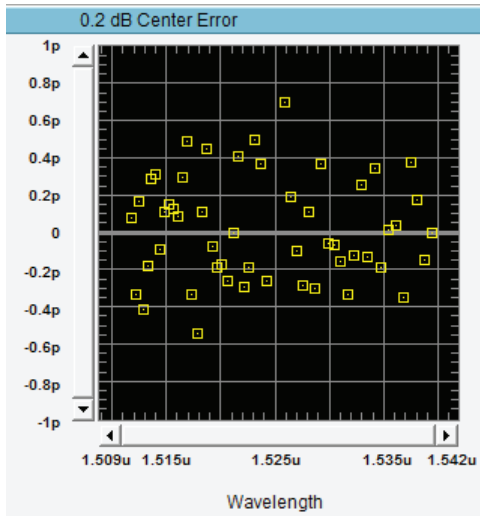

Less than  $\pm 1$  pm deviation of the measured center wavelengths from the known values (according to NIST SRM 2517a) acquired at 200 nm/s sweep speed

### Spectral loss testing on up to 8 channels in a single box

The 81606A Tunable Laser Source module in an 8164B Lightwave Measurement System mainframe, plus up to four dual power sensor modules, is sufficient for 8-channel devices, such as a CWDM multiplexer.

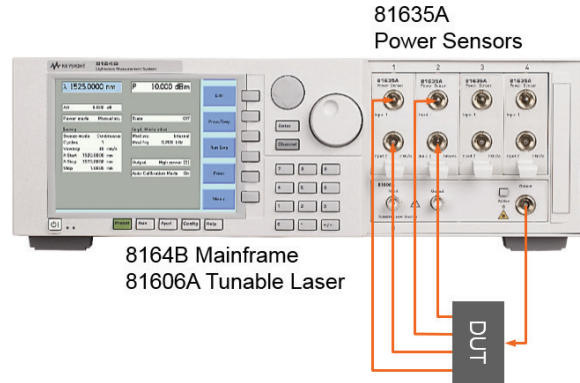

The N7700A photonic application suite helps getting to results fast.

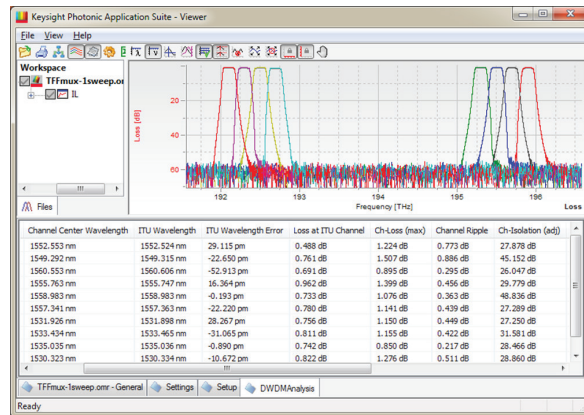

### Protect Your Investment

As a successor to the industry-standard 81600B, which we expect to continue in service for many years, the 81606A has also been designed to maximize compatibility with existing test stands and software.

- The modular 81606A uses the same 8164B mainframe slot and works with the same firmware version and the same front panel controls
- The N7700A application software engines can be updated online to versions that use both models and add the new 81606A functionality
- The 816x VXI Plug&Play driver, widely used in customized software, can be updated to recognize the new model and operate in the same way, while providing enhanced spectral performance
- The SCPI command set remains the same and has a few extensions for the additional functionality



## Applications

### Optical Transient Measurements

[www.keysight.com/find/mppm](http://www.keysight.com/find/mppm)

#### Making transient optical power measurements with the N77-Series multiport optical power meter

Measuring optical power level changes, to determine fiberoptic switching times or to observe transient fluctuations from fiber movement or network reconfiguration, goes beyond the design of most fiberoptic power meters. These instruments are generally designed for calibrated determination of optical power levels that are constant or change in synchronization with other instruments. The typical sample rates like 10 kHz, data capacity of perhaps 100,000 samples, and data transfer speed to the controller are often insufficient for general time-dependent measurements. Instead alternative setups, like a fast optical-to-electrical converter combined with an oscilloscope, have been used and described in standards. These often sacrifice optical power calibration, involve additional integration effort, and are likely implemented with an over-dimensioned scope bandwidth.

The N7744A 4-port and N7745A 8-port optical power meters now offer the performance to make these measurements with a small self-contained programmable instrument that is used together with a controller computer. These power meters accurately log optical power at selectable sample rates up to 1 MHz, store up to 2 million samples per port, allow fast data transfer via USB or LAN and support simultaneous measurement and data transfer for continuous power monitoring without interruption.

Now the new N7747A and N7748A high sensitivity power meters can be used in the same way, with the difference that the lower bandwidth reduces the sampling rate to 10 K/s, but with lower noise and for much weaker signals. This can be optimal for transient crosstalk measurements.

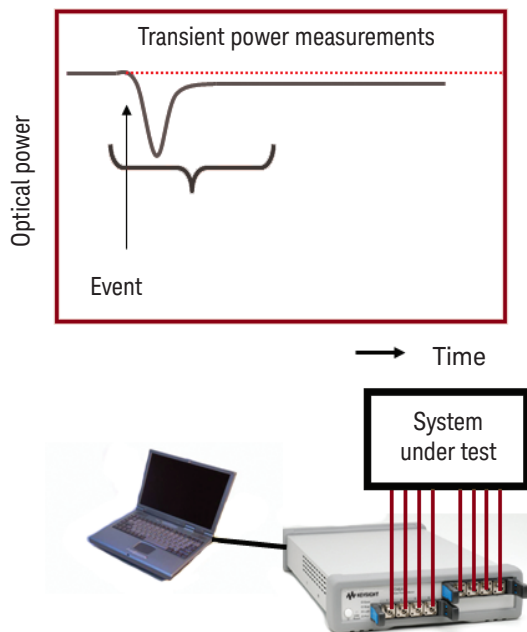

#### Logging functionality basics

The measurement of time-dependent signals is realized with the easy-to-use logging function of the optical power meters. The logging function is set up by choosing the number of logging samples,  $N$ , and the averaging time of each sample,  $t$ . The logging measurement is then started with a programming command or an electrical trigger. The instrument can be configured to make the complete logging measurement of  $N$  samples or individual samples when triggered. For logging time-dependence, the measurement will usually be configured for logging all samples without pause over a total time  $Nt$ .

For completeness, note that the instruments also have a stability function that performs similarly, but with a programmable dwell time between samples. This is used for measuring longer term changes in optical power, as for source stability tests, and is not discussed here further.

The N7744A and N7745A multiport power meters, MPPM, can perform this logging simultaneously on optical signals from up to 8 fibers. The averaging time can be chosen between 1  $\mu$ s and 10 s, and up to 1 million samples can be taken. During the logging, a wide dynamic range can be recorded, exceeding 60 dB for averaging times of 100  $\mu$ s or more, and the power range maximum can be chosen between -30 dBm and +10 dBm in 10 dB steps. The MPPM can also be configured to begin a new logging measurement of  $N$  samples as soon as the previous measurement finishes. The existing results can be uploaded to the controller computer during the new measurement. This set of functionality provides two methods for making transient measurements, which we label here as triggered logging and continuous logging methods.

Triggered logging is used to measure a fixed number of samples, starting from a time chosen by software or an electrical signal to synchronize with the event to be measured. This is most useful when the timing of the event to be measured is also controlled, as for setting a switch or shutter, changing an attenuator, or blocking an input signal to an amplifier or ROADM (reconfigurable add/drop multiplexer). Since 1 million samples can be stored per port, a single logging measurement is usually sufficient. The multiple ports of the instrument make it easy to watch, for example, all output ports of a switch during reconfiguration. Measurements like described in the IEC standard 61300-3-21 for switching time and bounce time or transient characterization of optical amplifiers can be accomplished with this method.

Continuous logging is especially useful for recording events with unpredictable timing as well as for keeping a very large number of samples. A typical application would be the measurement described in IEC 61300-3-28 for transient loss, where the power from fibers is monitored for change due to mechanical disturbances. This method can be programmed using the same logging function mentioned above, with the extension that the complete logging sequence is repeated multiple times. For such real-time processing while data is being gathered, multi-threaded programming is useful to avoid interruption of the data stream, as now available in Keysight VEE 9.0 and higher.

For a more detailed description refer to: Application Note 5990-3710EN: Making Transient Optical Power Measurements with the N7744A and N7745A Multiport Optical Power Meter.

[www.keysight.com/find/n7700](http://www.keysight.com/find/n7700)

### Swept-wavelength measurement solutions

Tunable laser instruments are used for spectral measurements of optical components and materials. The wavelength dependence is rapidly determined with selectable and very high wavelength resolution. The measurement systems can be flexibly configured to match the requirements of the application. Here we suggest some examples.

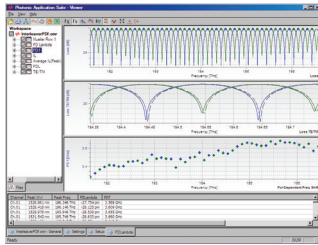

### Insertion loss measurement (IL)

Combining one or more optical power meters with the tunable laser source (TLS) permits measurement of optical power vs. wavelength. Often this is used to find the ratio of power at the input of a component to the output power, commonly called insertion loss and expressed in dB. While the TLS tunes the wavelength over the chosen range, the power meters periodically sample the power for the desired number of measurement points. These samples are synchronized with the TLS sweep by a trigger signal for accurate association with the corresponding wavelength. Use of multiple power meters allows simultaneous measurement of outputs from multiport components like multiplexers, splitters and wavelength switches. A setup can combine the 81606A, 81600B, 81960A, 81940A or 81980A TLS with power meters from the 816x-series modules or the N774x-series multiport power meters and the free N7700A IL software. Easy programming of these “lambda scan” routines uses the free 816x Plug&Play driver and can be enhanced with the N4150A Photonic Foundation Library (PFL) of measurement functions. Reflection spectra (return loss) can also be measured, by connecting the 81610A return loss module after the TLS.

### Performance considerations

High wavelength accuracy and repeatability, particularly during fast wavelength scans, is assured with the built-in wavelength monitoring in these laser sources. These “lambda-logging” data are synchronized with the measurement triggers to the power meters. For highest absolute and relative wavelength accuracy during high-speed sweeps, the 81606A includes a built-in gas cell reference and faster bandwidth and sampling by the wavelength monitor.

InGaAs power detectors are best for such measurements due to the small variation in responsivity over the single-mode fiber wavelength range (1260 to 1630 nm) and high sensitivity and dynamic range. The N7744A and N7745A power meters are especially well adapted to these swept-wavelength measurements with fast sampling rates and high signal bandwidth that allow high-resolution measurements at high sweep speeds without distortion of the measurement trace.

Faster data transfer raises throughput dramatically, especially at high port counts. When measuring weaker signals, like for channels with crosstalk better than -60 dB or when the laser power is split to multiple devices, the N7747A or N7748A power meters can be used. The cooled detectors and low-noise amplifiers provide the highest sensitivity.

When insertion loss is low at some wavelengths and very high at others (high dynamic), like in DWDM components, it is very important that the broadband spontaneous emission from the TLS is very low. This avoids light transmitted in the passband of the component when the TLS wavelength is outside this band especially for measuring components with more than 40-50dB dynamic. The 81606A TLS provides light with practically no source spontaneous emission (SSE), even very close to the laser line. The dynamic range of the power meters is then important too. Keysight power meters use linear transimpedance amplification of the detector photocurrent for stability and accuracy, even at low power and high sampling speed. For fast measurements of dynamic up to about 55 dB, the N7744A and N7745A can do this with a fixed power range during a single wavelength sweep of the laser. Even more range is achieved by measuring with multiple power ranges and “stitching” the traces to capture both the strongest and weakest signal, especially when using the high sensitivity N7747A or N7748A. The N7700A FSIL and IL engines, as well as the 816x Plug&Play driver provide such stitching automatically.

### Polarization dependent loss (PDL)

Optical signals are generally polarized and the variation in insertion loss with polarization must be determined. Measurement involves determining the maximum and minimum IL vs. polarization for all desired wavelengths, and all combinations of linear and circular polarization. Fortunately this can be done by measuring swept-wavelength IL at a set of four (or optionally six) polarizations, from which any other IL can be calculated. This is known as the Mueller Matrix method. The setup includes a polarization controller after the TLS, that sets the polarization of the light into the device under test. The 8169A polarization controller does this by sequentially setting each polarization for separate TLS sweeps, support by the PFL software. But the newer N7786B rapidly switches polarization and monitors the SOP and power so PDL can even be measured in one wavelength sweep. This innovative method and calculations such as resolution of TE/TM spectra and determination of polarization dependent wavelength are provided in the N7700A IL/PDL engine software.

Further details can be found in the brochure for the “N7700A Photonic Application Suite”, 5990-3751EN and “Programming Keysight Technologies Continuous-Sweep Tunable Lasers”, 5992-1125EN.

[www.keysight.com/find/n7700](http://www.keysight.com/find/n7700)



There is an increasing number of fiberoptic components that integrate photodiodes with passive optical functionality and with electronic circuits. Important examples are:

- Integrated coherent receivers (ICR)
- 100GBASE-(C)LR4 ROSA components ROSA components
- Optical channel monitors

These all have optical input ports and electrical or RF output ports. The photodiodes produce photocurrent from the optical signal after it has passed the passive sections, such as polarizer, splitter, or interferometer. Thus the responsivity of the photodiodes to the input signal, measured in mA/mW, in dependence of wavelength and polarization is a fundamental performance measure of the component.

Measurement of such devices can be made in the same way as mentioned on Page 9 for PDL, by replacing the optical power meter with an instrument for logging photocurrent. The N7700A-100 IL/PDL engine software supports this setup.

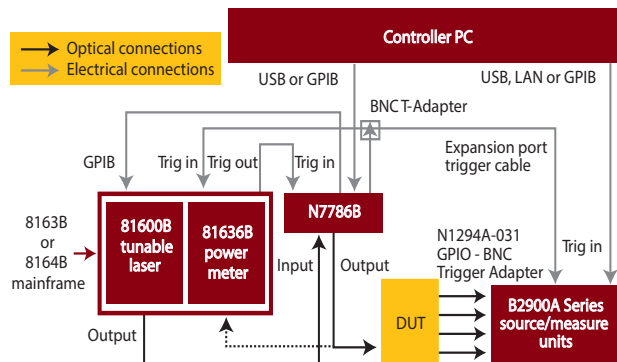

Setup example for measuring optoelectrical devices with the B2900A

From the swept-wavelength measurement of the input optical power and the output diode current, the responsivity spectra are calculated as the average vs. state of polarization.

The maximum and minimum responsivity vs. SOP are also determined, which is especially useful for polarizing components like ICR for polarization. multiplexed signals. The polarization dependence is also displayed as PDL and the TE/TM traces are also calculated, as for optical-optical measurements.

For balanced-detection components, the common-mode rejection ratio (CMRR) of detector pairs is also determined.

The N7700A-100 software also has added functionality for measuring high PER with an additional measurement step that continuously scans a large number of SOP at a set of fixed-wavelength points. The user can choose the number of points to balance measurement time vs resolution. Good accuracy to well beyond 20dB can be obtained.

For devices like ICR, where the photocurrent is converted to an RF output signal, the "CW" photocurrent can typically be accessed from the pins for applying bias voltage.

For higher flexibility in the polarity and isolation of the biasing, the B2900A-series source measure units can also be used for detection, as shown here.



B2900A-series source measure unit

Support for these instrument is added to the N7700A-100 IL/PDL engine.

Further details can be found in the brochure for the N7700A Photonic Application Suite, 5990-3751EN and "Wavelength and polarization dependence of 100G-LR4 components", 5992-1588EN.



### All-states method for PDL and PER

The all-states PDL method for measuring polarization dependent loss by scanning the polarization of light input to the DUT over a large sampling of all possible states is a good way to measure components with little wavelength dependence, so that the wavelength can be fixed during the scanning. Fiberoptic couplers, splitters and isolators are typical components to test this way. Tests of polarization beam splitters and other devices designed for high PER also benefit from this method, because it samples the states with high polarization extinction.

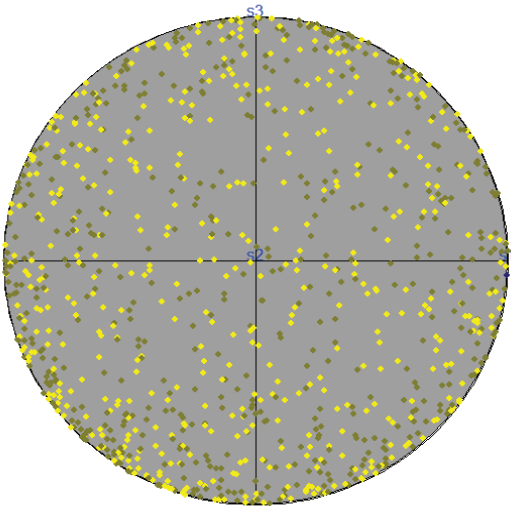

Random sampling of SOP, represented on the Poincaré sphere.

Conventionally, this method has been realized by monitoring output optical power while scanning the input polarization, so that the accuracy is limited by the polarization dependence of the instrumentation, particularly the polarization controller. This was generally addressed by using mechanical movement of fiber loops, which can give very low polarization dependence of the power level, but has limited speed.

Faster accurate measurements now use the Keysight N7785B synchronous scrambler, which can be programmed for repeatable stepping through a sequence of polarization states at high speed while producing synchronization triggers. This can be used to shorten total measurement time, allow optimized detector averaging times, and normalize the results to remove the polarization dependence of the setup from the results.

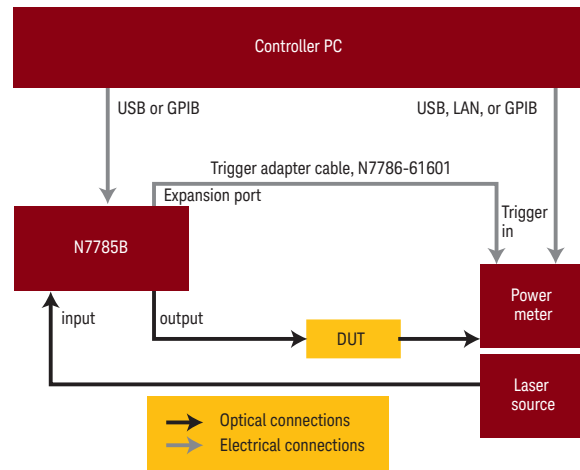

A typical setup for synchronized all-states measurement.

For measuring PDL values up to 1 dB, about 100 samples are sufficient for the minimum/maximum ratio to come within 10% of the full PDL value. So a good measurement is achieved in less than 50 ms using 100  $\mu$ s averaging time. For measuring PDL values significantly below 0.1 dB, the noise is a limitation and longer averaging time is needed. Using 10 ms averaging time with a stable setup has been seen to give repeatability corresponding to less than 0.005 dB over times of 10 minutes or more. The 10 ms averaging time also supports use of the coherence control function of the laser sources, if needed to avoid interference effects due to reflections in the setup. Again for these values, good measurements are obtained with sequence lengths of about 100.

The range of high extinction ratio measurements amounts to how well the lowest transmission value is determined. When using a random pattern of SOP, this is improved by using many samples and having minimum SOP variation during the averaging time of the sample. This latter condition is an advantage of the polarization switching vs. continuous scanning. To assure measurements above 30 dB PER, a minimum of 20 k samples is recommended. For example, using 100  $\mu$ s averaging time, the 20 k sequence requires 8 s.

For further details, refer to 5990-9973EN, "All-States Measurement Method for PDL and PER with a Synchronous Polarization Scrambler - Application Note".

[www.keysight.com/find/oct](http://www.keysight.com/find/oct)

### General

Optical power meters for testing fiberoptic components use semiconductor photodiodes as detectors to generate electrical current proportional to the incident optical power. This photocurrent is then measured, typically with a transimpedance amplifier and analog-to-digital converter, to determine that power. That requires the conversion factor from mA current to mW power, which depends on the wavelength of the light and combines contributions from the properties of the detector as well as any optics used to collect the light. Calibration of the power meter thus involves tracing and recording the wavelength dependent responsivity and including this data with the instrument.

### Responsivity is key

This responsivity is one of the key considerations in choosing a power meter for a particular application. First, the instrument must be calibrated at the wavelength of the light to accurately determine the absolute power level. If only relative power change will be measured, as for determining the attenuation of a passive optical component, this calibration factor is not actually needed. However it is still necessary that the detector has sufficient responsivity for this wavelength. For measuring light that is distributed over a range of wavelength or for which the wavelength is not accurately known, it is also important that the variation of responsivity over wavelength is not too large.

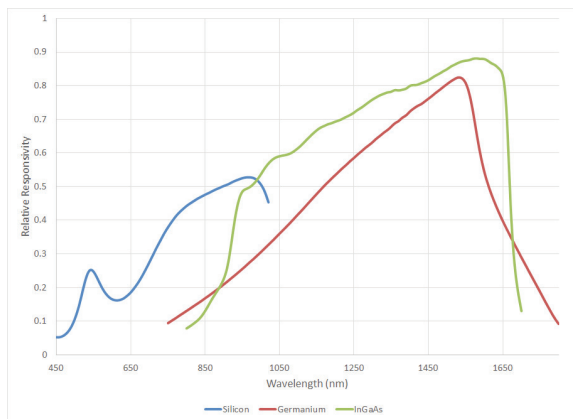

Wavelength dependent responsivity examples for three power meters with different detector materials

### Responsivity examples for different detector materials

Example responsivity spectra for power meters based on three commonly used semiconductor materials are shown in the figure above. These are actual calibration data for individual instruments and the curves can vary somewhat from unit to unit, but the spectral shapes are primarily determined by the detector material. The values displayed on the y-axis correspond approximately to conversion efficiency in mA/mW. For wavelengths supported by standard single-mode fiber from about 1250 nm to 1650 nm, the InGaAs detector (like used here in the Keysight 81624B optical head) provides the highest performance

with high responsivity and relatively low wavelength dependence. InGaAs (actually a shorthand label for the alloy chemical formula  $\text{In}_x\text{Ga}_{1-x}\text{As}$ ) as a direct-gap semiconductor also typically provides the lowest noise level which permits power measurements over the widest dynamic range.

### Make your choice

The germanium detector (81623B) is useful over an even wider wavelength range and is less expensive, so these make good general purpose power meters. However the steep wavelength dependence above about 1545 nm makes the measurements more sensitive to wavelength uncertainty or instability. For shorter wavelengths, including visible light, the silicon detector (81620B) provides good responsivity. This can be used for the 650 nm red light used with POF (plastic optical fiber), but as discussed in the following is also an attractive alternative to germanium for the widely used 850 nm wavelength range.

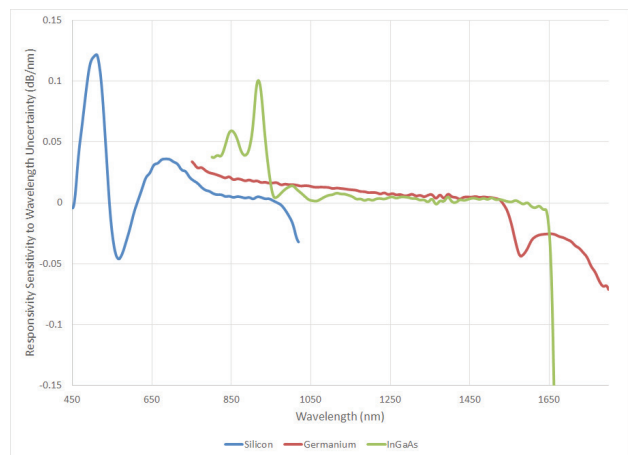

Sensitivity of the responsivity to wavelength, calculated from the responsivity slope

## 850 nm power measurement

Fiber links for transmission over short distances, like within buildings and data centers, predominantly use multimode fiber and signals at 850 nm. Another less common wavelength used with this fiber is 1300 nm. The wavelength here is a nominal value and the actual wavelength can be offset substantially. For example the IEEE 802.3 standard requires center wavelength to be between 840 nm and 860 nm. Other applications may tolerate wider wavelength variation. If the actual wavelength of such sources is not used to make the power measurement, this variation contributes to the measurement uncertainty. With this in consideration, the silicon detector has clear advantages. The responsivity is about five times stronger than for germanium, which itself is stronger than for the InGaAs detector. But more important for measuring moderate signal levels like 1 mW is the dependence on wavelength, as shown expanded for this wavelength range in the figure below.

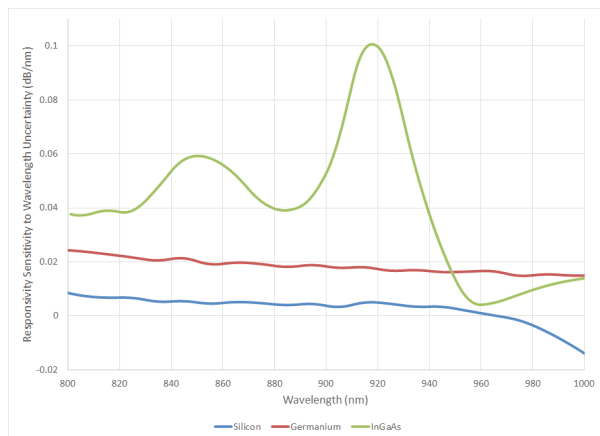

Sensitivity of the responsivity to wavelength, calculated from the responsivity slope, for the short wavelength region

## It depends on the application

The germanium has moderate dependence, but a 10 nm wavelength offset will still cause about 0.2 dB measurement error (4.7%), which is large compared to the  $\pm 4.0\%$  uncertainty specification or the 81623B when the correct wavelength setting is used. The comparable error for the 81620B with the silicon detector is only 0.05 dB.

This low wavelength dependence can also be convenient if additional wavelengths are used in this region, such as the 4 wavelength channels between 850 nm and 940 nm defined for the SWDM grid.

On the other hand, if a multimode fiber test setup will be used for both 850 nm and 1300 nm wavelengths, then the germanium detector is the best choice since silicon is not useful at the longer wavelengths, where the photon energy is smaller than the semiconductor bandgap.

## Considering other dependency

Finally when considering the requirements for accuracy specifications, the impact of other dependency besides wavelength should be considered. For measuring polarized light, like most laser signals, the polarization dependence can be a significant source of uncertainty because the polarization at the output of most optical fibers is not stable and changes with temperature and movement of the fiber. For measuring coherent light, again like laser signals, the impact of possible multiple reflections between the power meter optics and the fiber connector output leads to measurement instability, so such reflections should be minimized. This is characterized in the Keysight specifications as "spectral ripple" because the coherent interference will vary periodically with wavelength.

## Additional functionality Programming

Keysight optical power meters do support a programming command to read out the wavelength responsivity calibration data (like used for the graphs in this document). This can be used for example in post-processing to get calibrated absolute power values without needing to change the wavelength setting of the power meter each time that the wavelength of the signal is changed. That can be especially helpful when the power meter logging function is used to record a series of samples, during which the wavelength setting cannot be changed. When used together with a tunable laser, this can provide the input power to a device under test, while the wavelength is swept. That is important for example to measure O/E conversion devices. It can also be used to normalize a reference measurement made on one power meter port for use as reference on other power meter ports connected to the device.

## Additional functionality - Logging

Besides simple power measurements, Keysight optical power meters provide higher functionality, especially including the logging function just mentioned and flexible internal and external triggering functions for synchronization with other instruments or the DUT itself. The optical head models mentioned above have memory for up to 20k samples with individual averaging times selectable between 100  $\mu$ s and 10 s duration. Other models support logging of up to 1M samples and averaging times down to 1  $\mu$ s. The optical heads also provide an analog output signal with a voltage proportional to the input optical power. Especially combined with the large 5 mm diameter detector area, this supports various automated alignment procedures. The heads can be used to measure open beams and have a selection of fiber connector adapters. As external heads connected to the mainframe with a cable, these can be located conveniently on optical tables or workbenches.

With the need for 100 Gb/s links in data communication, the IEEE 802.3 Ethernet Working Group has included implementations for reach up to 10 km (100GBASE-LR4) or, with tighter tolerances, 30 km (100GBASE-ER4) by using four wavelength channels in single mode fiber, centered at: 231.4 THz (1295.56 nm), 230.6 THz (1300.05 nm), 229.8 THz (1304.58 nm), 229.0 THz (1309.14 nm).

### Spectral measurements for passive components

The spectral response of components used in WDM links is a key factor in determining link performance at the physical level. The insertion loss (IL) of passive components influence the signal power budget. The wavelength selectivity of filters used for multiplexing and especially demultiplexing, characterized from traces of IL vs. wavelength with parameters like ripple or flatness in the passband and isolation of wavelength outside the passband, is important for signal stability and avoiding crosstalk. Reflections, parametrized as return loss (RL), can also degrade link performance and should be controlled. Low dependence of these response parameters on the polarization of the optical signal is also needed to avoid fluctuations in power, because the polarization state can change randomly along fiber links. So passive WDM components are typically tested and verified by measuring IL, PDL and often RL across the applicable wavelength range. Using a tunable laser source at the common side of an LR4 multiplexer, for example, allows all four lane ports to be measured simultaneously with synchronized power meters. A block diagram for such measurements is shown below, implemented using the N7700A-100 application software package. Details for the instrumentation are given further below.

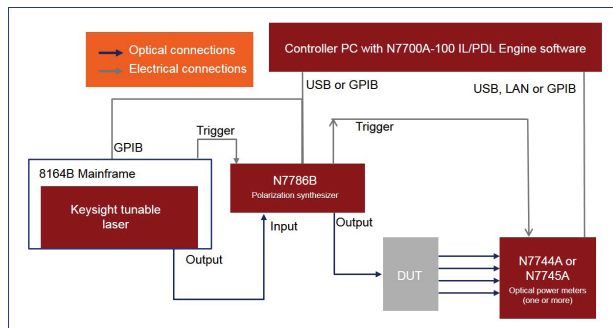

Block diagram for swept-wavelength IL & PDL measurements

As shown in the measurement results diagram the insertion loss spectrum for each output port, averaged over all states of polarization. That would be the IL of unpolarized input signal. Spectra of the polarization dependent loss are also determined. This can also be shown as two IL spectra for each port corresponding to the IL for the input polarization states for maximum and minimum transmission. For planar devices like wafer chips, this usually corresponds to polarization parallel or perpendicular to the chip surface (TE or TM).

The N7700A software also provides for calculation of key analysis parameters for the passbands, like wavelength offset, bandwidth, isolation, ripple and maximum in-channel IL and PDL.

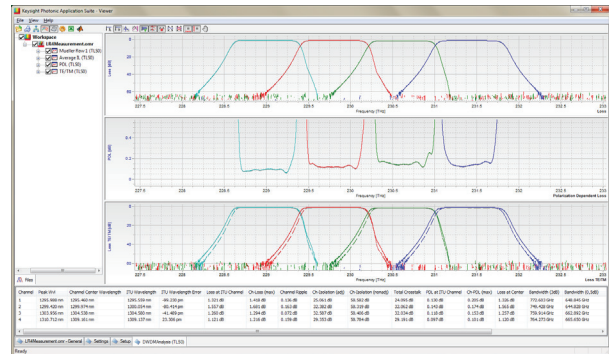

Measurement result for a 4-port multiplexer, including data analysis

### Spectral measurements for components with integrated detectors

Another class of components requiring similar measurements is increasingly important. The optical detectors used in receivers are also characterized with respect to relevant wavelength and polarization dependence, but the response usually doesn't have strong variation. However when the detectors are integrated with filters or other passive components, this assembly needs to be characterized in a similar way as for the individual components. An important example is the LR4 receiver optical subassembly (ROSA), which can include the demultiplexer optics, photodiodes for detecting each signal lane, and often some electronics for transimpedance amplification for the RF signal carried on the detected photocurrent. Such a structure is shown schematically in figure below.

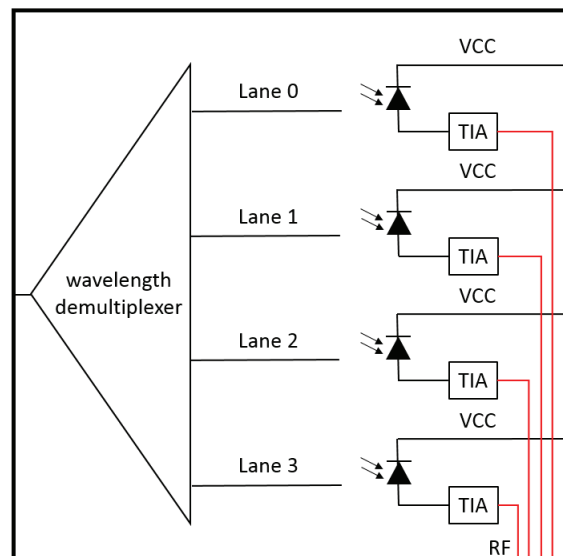

Schematic diagram of an LR4-ROSA device

The electrical contacts on the ROSA that are used for providing bias voltage to the photodiode detectors can also be used to access the photocurrent while an input optical signal is varied in wavelength and polarization to measure responsivity response parameters. Such a solution is shown in the diagram below.

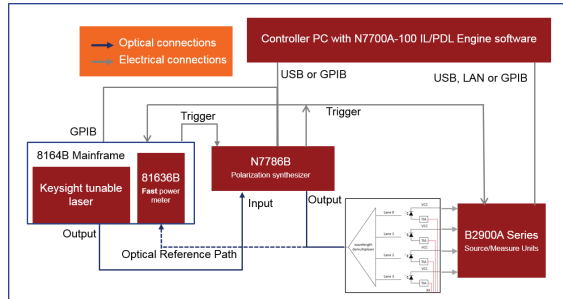

Block diagram for measurements of wavelength and polarization dependent responsivity

This measurement uses source/measure units to apply bias voltage and measure the photocurrent from the integrated detectors of the DUT. The results are then interpreted as responsivity in units of mA current per mW optical input power. So the absolute input optical power is measured with an optical power meter and then applied to the DUT. Again both the polarization-averaged response as well as the minimum and maximum responsivity vs. polarization are determined by the software. An example is shown below.

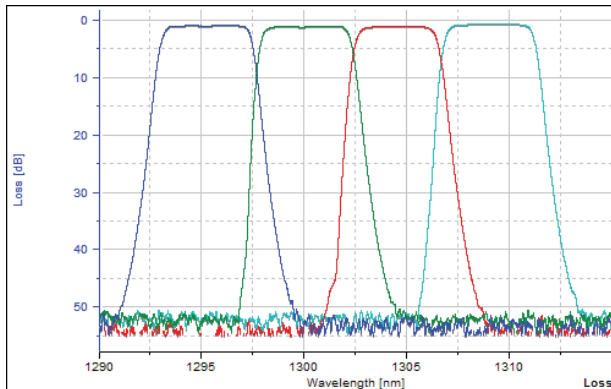

Sample measurement of an LR4-ROSA device

The fundamental test for these network elements is the bit error ratio, demonstrating reliable operation in digital data transmission systems and networks. The basic principle is simple: the known transmitted bits are compared with the received bits over a transmission link including the device under test. The bit errors are counted and compared with the total number of bits to give the bit error ratio (BER). The applied test data signal can be degraded with defined stress parameters, like transmission line loss, horizontal and vertical distortion to emulate worst-case operation scenarios at which the device under test has to successfully demonstrate error free data transmission. Obviously, this test is of fundamental importance for receiving network elements, due to the manifold impairments occurring on optical transmission lines. Therefore, many all optical transmission standards define such stressed receiver sensitivity on the basis of a BER measurement. The basic test methods and setups are usually very similar. However, the test conditions, the stress parameters or methods of stress generation vary from standard to standard, depending on the application area, transmission medium, data rate or data protocol.

Principle receiver stress test setup

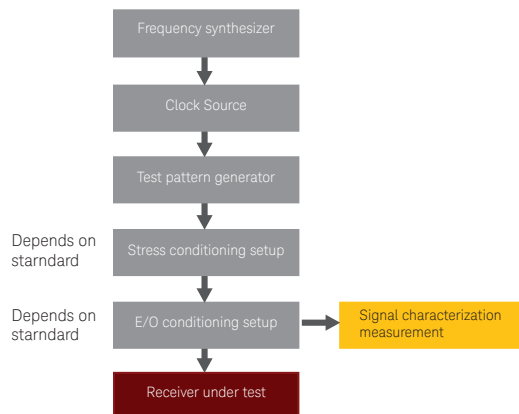

**OMA:** Optical Modulation Amplitude, measured in  $[\mu\text{W}]$  ("average signal amplitude")

**ER:** Extinction Ratio, high-level to low-level, measured in [dB] or [%]

**UI:** Unit Interval (one bit period)

**AO:** Vertical eye opening ("innermost eye opening at center of eye") [dBm or  $\mu\text{W}$ ]

**VECP:** Vertical Eye Closure Penalty in [dB]

**SEC:** Stressed Eye Closure, measured in [dB] (used for multimode applications such as 100GBASE-SR4 standard and 100G SWDM4 multi-source agreement)

**TDECQ:** Transmitter and Dispersion eye closure (for PAM4 signal)

[www.keysight.com/find/optical\\_stress](http://www.keysight.com/find/optical_stress)

The basic setup is sketched in the block diagram

- The frequency synthesizer: creates sinusoidally jittered clock, Periodic Jitter (PJ)
- The clock output from the clock source will be modulated with the sinusoidal jitter
- The electrical pattern generator creates the defined test pattern at the required rate
- The electrical stress conditioning setup adds various kinds of signal distortion onto the test pattern
- The E/O conditioning setup modifies the electrical stress signal depending on the standard:
  - The electrical-to-optical- converter converts the electrical stressed test signal into the corresponding optical stressed signal.
  - The optical attenuator emulates the transmission line loss and sets the optical modulation amplitude to the required level
- The optical stressed signal is fed to the optical receiver
- The receiver's data output signal is lead to the error detector, which compares the input and output data test patterns, detects errors and calculates the bit error ratio

What is optical stress?

The figures below illustrate optical stressed signals for NRZ and PAM4 optical receivers.

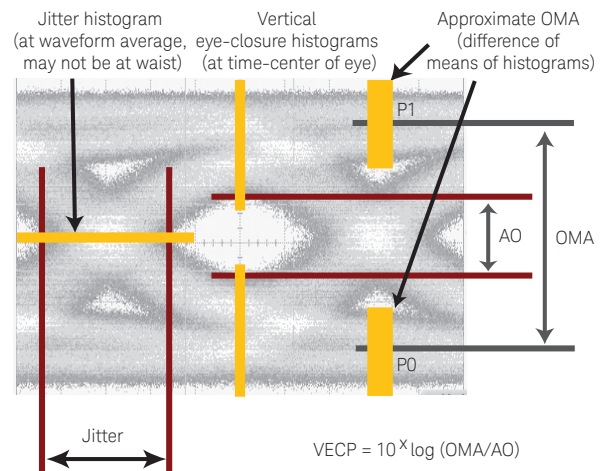

Definition of the optical parameters for NRZ signals

$$TDECQ = 10 \log_{10} \left( \frac{\sigma_{ideal}}{R} \right)$$

$\sigma_{ideal} = \left( \frac{OMA}{6Q^{-1} \left( \frac{2}{3} SER_{target} \right)} \right)$   
 RMS noise added to **ideal** Tx to achieve the target BER  
 $R = \sqrt{\frac{\sigma_n^2}{C_{eq}^2} + \sigma_s^2}$   
 noise of ref. Rx (scope)  
 RMS noise added to **actual** Tx to achieve the target BER

### Stress conditioning setup:

Stress conditioning varies depending on the standard and the speed class of the component. But the principle of stress conditioning remains the same:

- First, this block adds different types of jitter, like random jitter, periodic jitter or sinusoidal jitter, to generate defined horizontal closure of the test pattern's eye shape
- Second, this block exposes different types of amplitude distortions, like sinusoidal amplitude interference, Gaussian noise and low-pass filtering, to generate defined vertical closure or TDECQ of the eye-shape

### Stress conditioning for 40 GBASE-LR4 and 100 GBASE-LR4, ER4

- Sinusoidal amplitude interferer 1: Causes Sinusoidal Jitter (SJ) in conjunction with limiter
- Gaussian noise generator: Causes Random Jitter (RJ) in conjunction with limiter
- Limiter: Restores signal edges (fast rise and fall times)
- Sinusoidal amplitude interferer 2: Causes additional Vertical Eye Closure (VECP) and Sinusoidal Jitter (SJ)
- Low-pass filter: Creates ISI-induced Vertical Eye Closure (VECP)

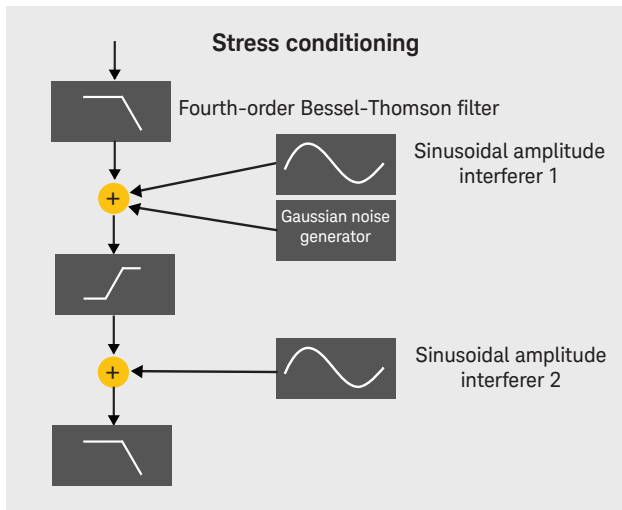

### Stress conditioning for 200 and 400GBASE according to the IEEE 802.3bs standard

- Stress conditioning for 200 and 400GBASE according to the IEEE 802.3bs standard
- Sinusoidal amplitude interferer 1: Causes Sinusoidal Jitter (SJ) in conjunction with limiter
- Limiter: Restores signal edges (fast rise and fall times)
- Sinusoidal amplitude interferer 2 and Gaussian noise generator: Causes additional TDEC as well as random and Sinusoidal Jitter (RJ/SJ)
- Low-pass filter: Creates ISI-induced TDECQ penalty

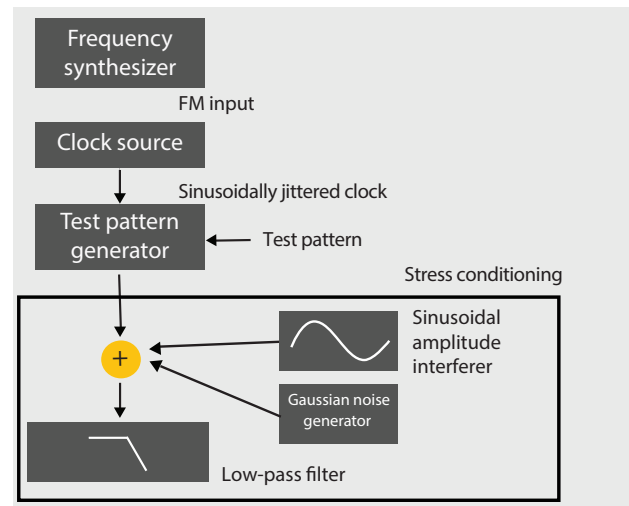



### Reference transmitter conditioning setup

This setup varies depending on the speed class and number of lanes. For single lane setups it is just an E/O converter and an aggressor lanes are required: they can be generated by the transceiver itself, which is operated in optical loopback, the stress signal being inserted using an optical WDM multiplexer or a simple coupler.

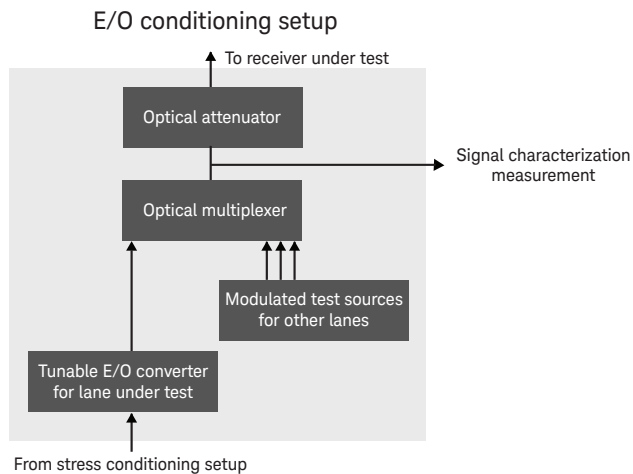

### Tunable E/O converter for selecting stressed lane under test:

Modulated with stressed test signal.  
OMA set to „stressed receiver sensitivity spec“.

- Wavelength ( $\lambda$ ) tuned to corresponding worst-case sensitivity of RxuT
- Or fixed wavelength ( $\lambda$ ) in specified range of RxuT

### Modulated test sources for other lanes:

Modulated simultaneously with valid standard pattern.

- OMA set to highest „difference in receive power spec“.  
Wavelength ( $\lambda$ ) tuned to corresponding worst-case crosstalk to lane under test.
- OMA set to highest „difference in receive power spec“ plus increment of loss variation of lane under test, plus increment of isolation variation to lane under test. Fixed wavelength ( $\lambda$ ) in specified range of RxuT

### Stress signal calibration

Test signal calibration and verification

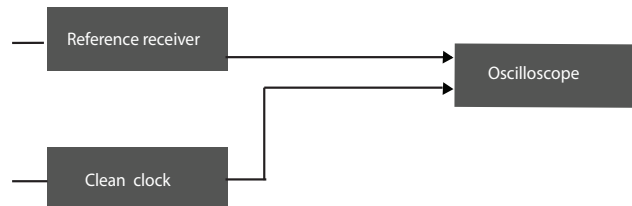

### Reference receiver:

The reference receiver is usually part of the (optical) oscilloscope, whose bandwidth and filter-shape can be adjusted depending for the particular application

### Oscilloscope:

Use clean, un-jittered clock to verify stressed signal.

### Device under test:

Optical receiver devices, especially those for data rates in the higher Gbps-range, are commonly exposed to extensive stressed receiver sensitivity tests during their design and qualification phase to verify their performance and to determine their margin against the requirements. The BER is measured under standard compliant stressed conditions at various optical modulation amplitudes (OMA) to BER down to  $10^{-12}$  or lower. In the manufacturing phase, BER tests are performed at a few different OMA points down to only BER of  $10^{-9}$  to reduce test time and cost. Applying this reduced test scheme in series implies that the device manufacturer knows very well the device margins. This leads to the requirements for a test solution with high accuracy and reproducibility regarding the stressed test signal generation. For the optical part of the stressed signal generation, this means maintaining high signal fidelity. This demand may lead especially for multimode fiber devices to some interesting test challenges. This catalog covers the test equipment needed to perform these tests.

Get more detail about Keysight's Optical Receiver Stress Test Solution here in this catalog.



Optical I-Q diagram

The I-Q diagram (also called a polar or vector diagram) displays demodulated data, traced as the in-phase signal (I) on the x-axis versus the quadrature-phase signal (Q) on the y-axis.

This tool gives deeper insight into the transition behavior of the signal, showing overshoot and an indication of whether the signal is bandwidth limited when a transition is not close to a straight line.

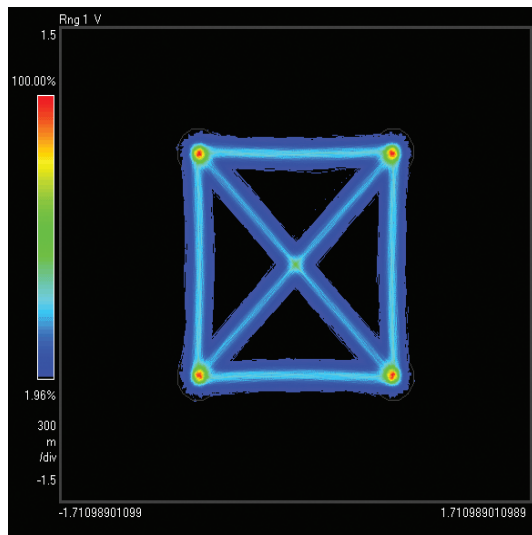

Optical constellation diagram

In a constellation diagram information is shown in a two-dimensional polar diagram, displaying amplitude and phase of the signal. The constellation diagram shows the I-Q positions that correspond to the symbol clock times. These points are commonly referred to as detection decision-points, and are called symbols. Constellation diagrams help identify such things as amplitude imbalance, quadrature error, or phase noise.

The constellation diagram gives fast insight into the quality of the transmitted signal as it is possible to see distortions or offsets in the constellation points. In addition, the offset and the distortion are quantified as parameters for easy comparison to other measurements.

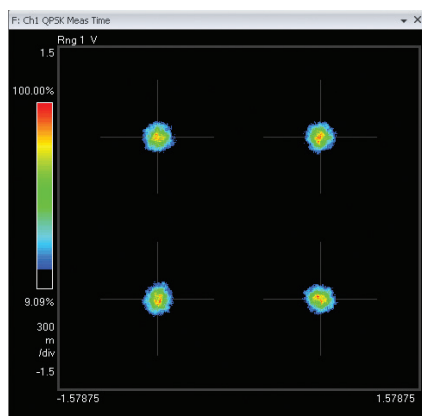

Symbol table/error summary

This result is one of the most powerful tools in the digital demodulation tools. With just a few scalar parameters, you can get full insight in your transmitter signal quality and get an indication on the most likely error sources. Additionally, demodulated bits can be seen along with error statistics for all of the demodulated symbols. The following list describes the parameters briefly:

- EVM: The error vector magnitude (EVM) gives an indication of the overall transmitter signal quality. The rms values of the magnitude (Mag Err) and phase errors (Phase Err) are reported as well
- Freq Err: Offset between carrier laser and local oscillator
- IQ Offset: Indicates the transmitter modulator I and Q bias alignment
- Quad Err: Quadrature error to verify the 90 degree bias point alignment in the transmitter modulator
- SNR (MER): Signal-to-noise ratio based on the EVM measurement
- Gain Imb: Gain imbalance between I and Q signal path in the transmitter

EVM	= 9.6577	%rms	26.092	% pk at sym	908
Mag Err	= 6.7412	%rms	-25.501	% pk at sym	908
Phase Err	= 7.5304	deg	-38.213	deg pk at sym	1744
Freq Err	= 18.505	MHz			
IQ Offset	= -30.783	dB	SNR (MER) = 17.758	dB	
Quad Err	= -1.4532	deg	Gain Imb = -0.059	dB	

0	11010100	11010101	00001010	01011100	01111010
40	11100100	10011010	11111001	01101111	10011011
80	00000110	01111100	11100000	01000101	10001111
120	00001100	01011000	10100101	10010010	11111001

Eye-diagram of I or Q signal

An eye-diagram is simply the display of the I (real) or Q (imaginary) signal versus time, as triggered by the symbol clock. The display can be configured so that the eye-diagram of the real (I) and imaginary (Q) part of the signal are visible at the same time. Eye-diagrams are well-known analysis tools in the optical ON/OFF keying modulation analysis. Here, this analysis capability is extended to include the imaginary part. This tool allows comparison of I and Q eye openings, illustrating possible imbalances very quickly.

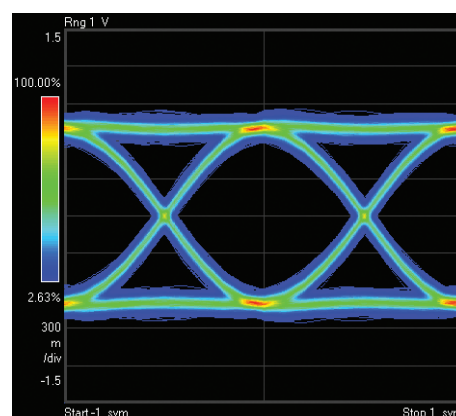

### Error vector magnitude

The error vector time trace shows computed error vector between measured I-Q points and the reference I-Q points. The data can be displayed as error vector magnitude, error vector phase, the I component only or the Q component only.

This tool gives a quick visual indication of how the signal matches the ideal signal.

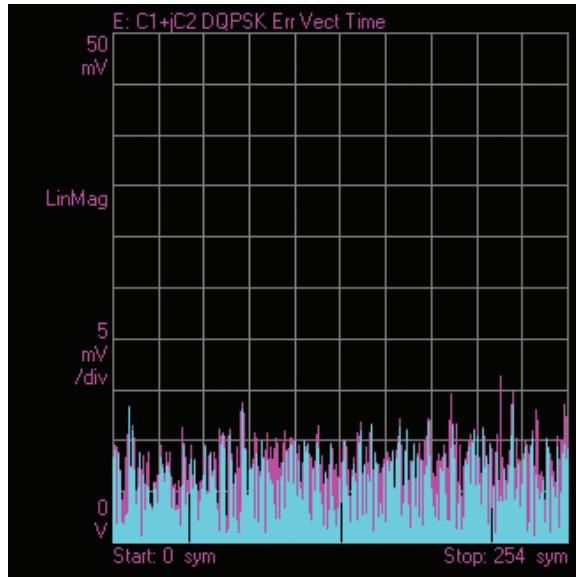

$$EVM [n] = \sqrt{I\ err [n]^2 + Q\ err [n]^2}$$

Where [n] = measurement at the symbol time  
 $I\ err = I\ reference - I\ measurement$   
 $Q\ err = Q\ reference - Q\ measurement$

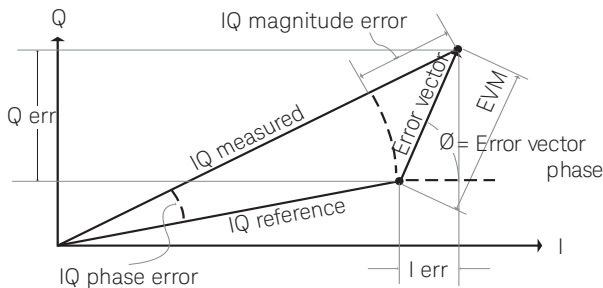

### Error vector limit test

The error vector concept is a very powerful way to qualify the overall performance of an complex modulated signal. Testing against a limit with pass/fail indication covers all typical error sources that could occur during transmitter manufacturing, alignment or along a link.

While deploying a new link operating with complex modulated signals, the pass fail test is an easy-to-use and powerful tool to test the physical layer signal quality against a defined limit. Having a physical layer signal in the desired quality is a prerequisite for well performing higher layer protocols.

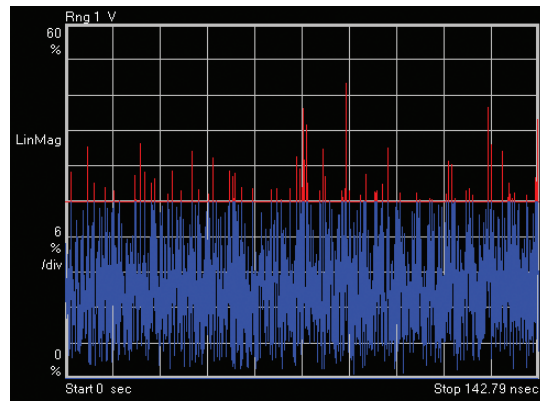

### Bit/Symbol/Error analysis

Beside the wide variety of physical parameters that can be analyzed, the optical modulation analyzer also offers the bit and symbol error analysis. Being able to detect the transmitted symbols and bits, enables comparison of the measured data against the real transmitted data.

With PRBS of any polynomial up to  $2^{31}$  and the option for user defined patterns, the optical modulation analyzer is able to actually count the symbol errors and measure the bit error ratio during a burst.

Having these analysis tools, it is now very easy to identify the error causing element, – transmitter, link or receiver – if a classic electrical point to point BER test fails.

In addition this feature offers the option to perform a stress test on a receiver, by exactly knowing the quality of the receiver input signal and being able to compare to the overall BER of the system.

[www.keysight.com/find/oma](http://www.keysight.com/find/oma)

### Customer configurable APSK demodulator

This new generic decoder allows the user to configure a custom decoding scheme in accordance with the applied IQ signal.

Up to 8 amplitude levels can be combined freely with up to 256 phase levels. This provides nearly unlimited freedom in research to define and evaluate the transmission behavior of a proprietary modulation format. The setup is easy and straightforward. Some examples are shown below.

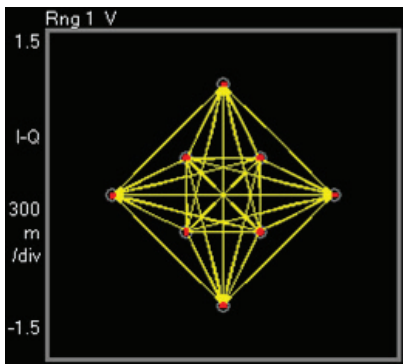
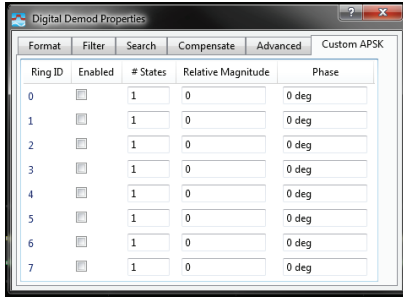

### Optical 8 QAM decoder

This example of a coding scheme can code 3 bits per symbol with a maximum distance between the constellation points, providing a good signal to noise ratio.

### Custom IQ demodulator

Constellation shaping is a new method to optimize IQ signals in the presence of fiber nonlinearities. The new custom IQ demodulator (Option BHK of the 89600 VSA software) is now supported by the optical modulation analyzer. Enter your unique non-standard constellation using the intuitive constellation editor and benefit from all the well-established analysis features like EVM, frequency error, IQ offset, quadrature error etc.

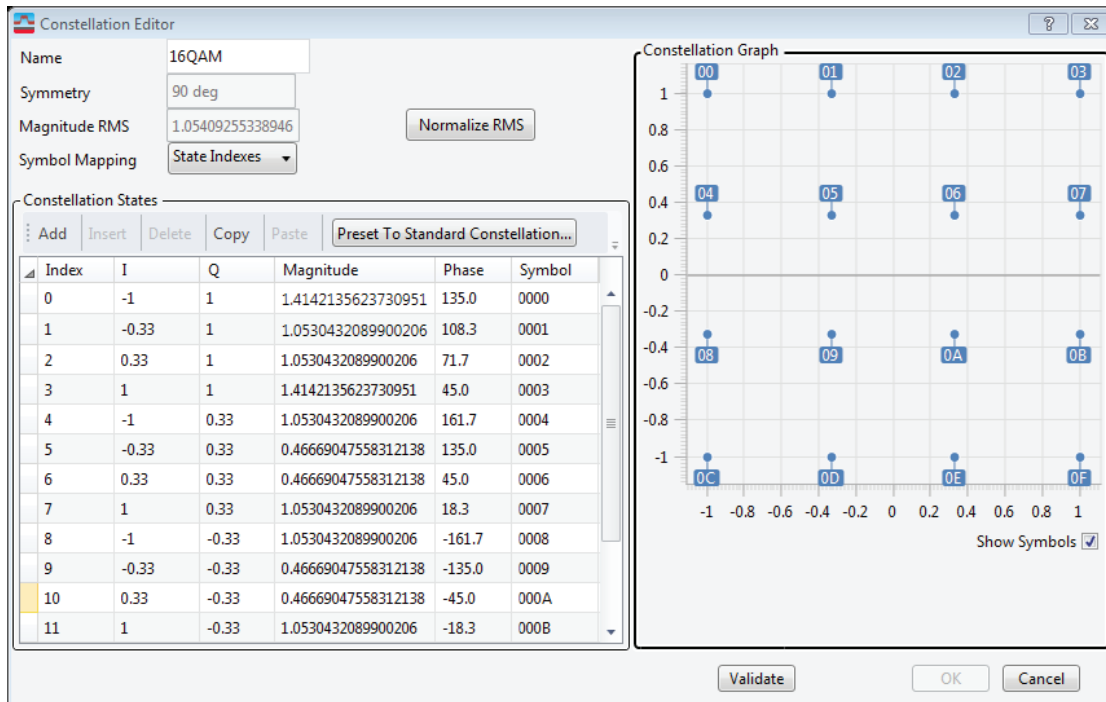

# Impairments in Complex Modulation Transmission

[www.keysight.com/find/oma](http://www.keysight.com/find/oma)

To describe the quality of a complex modulated signal, there are a variety of parameters in place.

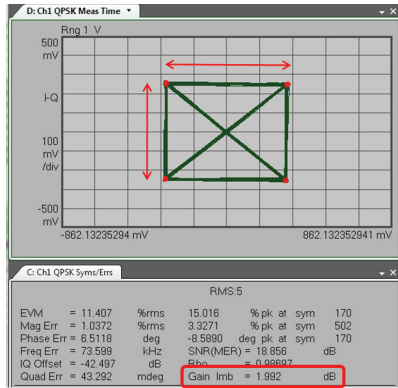

## Gain imbalance

Gain imbalance compares the gain of the I signal with the gain of the Q signal and is expressed in dB. The effects of IQ gain imbalance are best viewed in constellation diagrams where the width of the constellation diagram doesn't match its height.

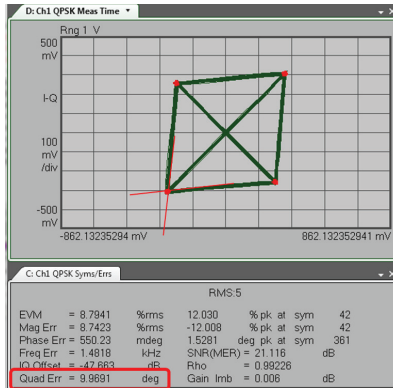

## Quadrature error

Quadrature error indicates the orthogonal error between the I and Q Quadrature-Phase. Ideally, I and Q should be orthogonal (90 degrees apart). A quadrature error of -3 degrees means I and Q are 87 degrees apart.

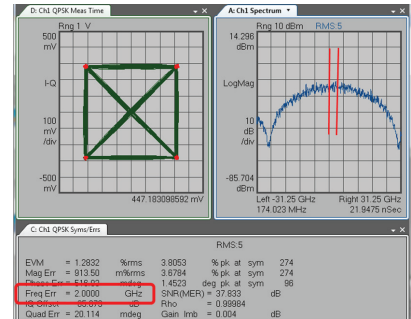

## Frequency error

Frequency error shows the carrier's frequency error relative to the local oscillator. This error data is displayed in Hertz and reflects the amount of frequency shift that the instrument must perform to achieve carrier lock.

Note: The frequency error does not influence the error vector magnitude measurement.

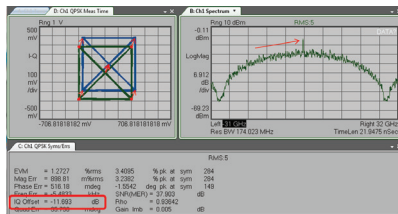

## IQ offset

IQ offset (also called I/Q origin offset) indicates the magnitude of the carrier feed through signal. When there is no carrier feed through, IQ offset is zero (-infinity dB).

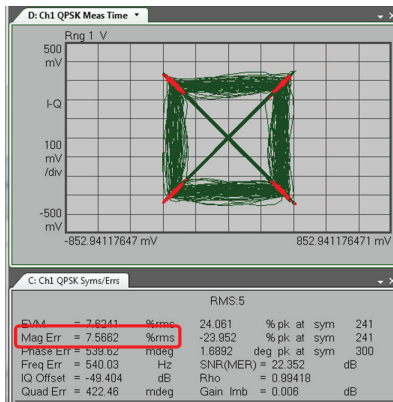

## Magnitude error

Magnitude error is the difference in amplitude between the measured signal and the I/Q reference signal.

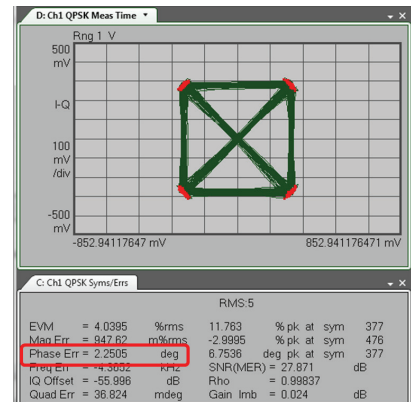

## Phase error

Phase error is the phase difference between the I/Q reference signal and the I/Q measured signal, as measured at the symbol time.

[www.keysight.com/find/oma](http://www.keysight.com/find/oma)

### SNR (MER) – signal to noise ratio (modulation error ratio)

SNR (MER) - Signal to Noise Ratio (Modulation Error Ratio) is the signal-to-noise ratio, where signal is the average symbol power of the transmitted waveform. The noise power includes any term that causes the symbol to deviate from its ideal state.

**Note:** SNR and OSNR are only equal in Gaussian noise limited systems, when proper normalization is used (OSNR is typically measured with 100 pm RBW).

$$SNR = 10 \log \frac{\sum_{n=1}^N (IQ \text{ reference vector at symbols})^2}{\sum_{n=1}^N (\text{error vector at symbols})^2}$$

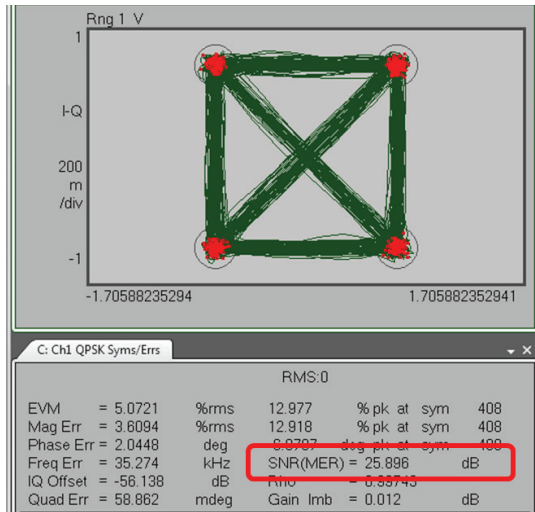

### Error vector and error vector magnitude as a global measure

EVM %rms is a normalized measure of all error vectors in the measured data burst. EVM is an excellent indicator summarizing most impairments of a complex modulated signal. Thus a good EVM %rms ensures low impairments including noise are present. Vice versa a bad EVM %rms does not indicate to a distinct impairment parameter. In this case the OMA and the other described parameters help to debug the root cause for worse EVM %rms.

Be aware EVM %rms is not a traceable and standardized parameter therefore it should be used only as relative measure.

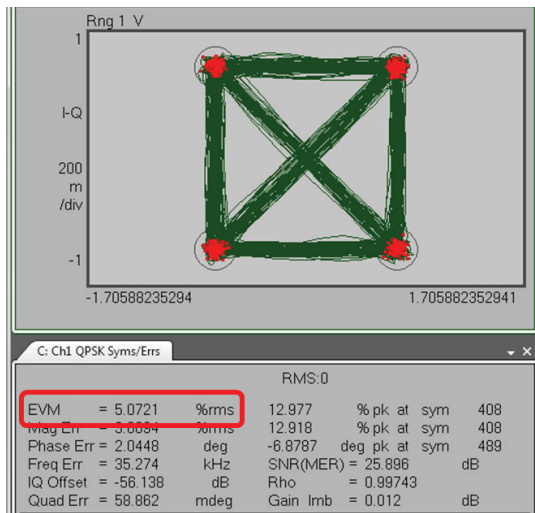

NEW

[www.keysight.com/find/oma](http://www.keysight.com/find/oma)

The next generation of telecom and datacom transceivers targets a net data throughput of 400 Gbit/s. Depending on the required reach, spectral efficiency and maximum power consumption target, there are different candidates to achieve 400G. With our flexible and scalable solution for a coherent reference transmitter and reference receiver, you can evaluate and develop each of the potential 400G candidates. It comprises:

- A laser to act as the carrier of the optical data signal.
- An arbitrary waveform generator (AWG) for flexible signal generation with 65 GSa/s (M8195A) or 92 GSa/s (M8196A).
- A software (81195A) to generate commonly used complex modulated data signals – The optical modulation generator (OMG).
- A dual-polarization IQ modulator, for example the optical multi format transmitter (OMFT) from ID Photonics that combines the modulator with RF driver amplifiers and an automatic bias controller.
- An optical modulation analyzer (N4391A) to receive and analyze the complex modulated optical data signals.

Below picture shows a setup that combines the reference transmitter with the reference receiver for system performance evaluation. In between, an erbium-doped fiber amplifier (EDFA) and an optical bandpass filter are connected. Individual parts of the system can then be replaced by your device under test to determine its contribution to the overall system performance.

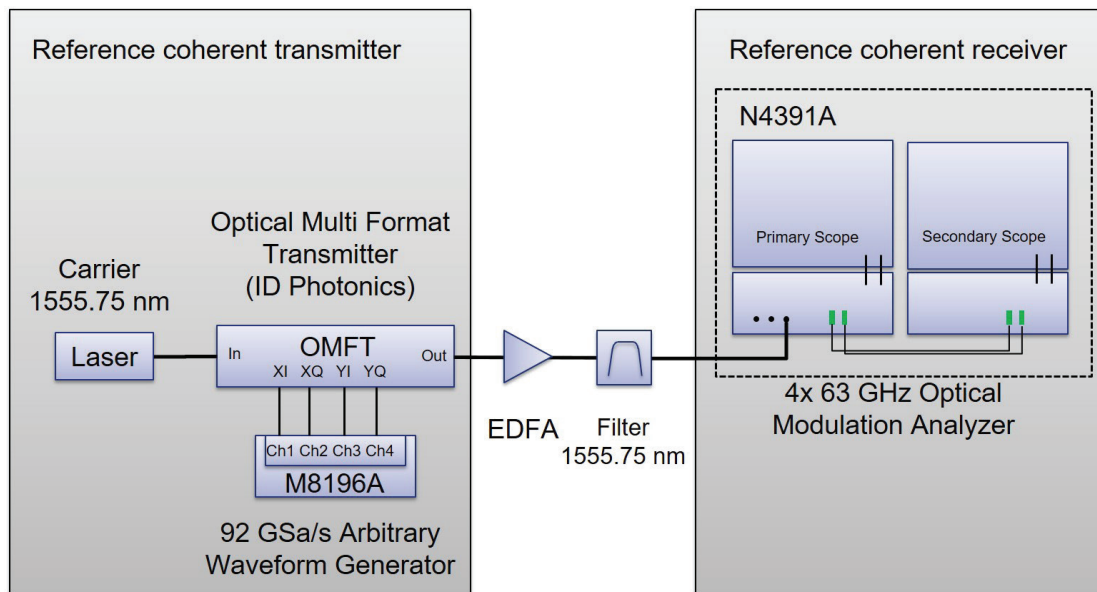

Two examples for 400G signals created and analyzed with the setup shown above

- |                                   |                                   |
|-----------------------------------|-----------------------------------|
| - 64 GBd PDM-16QAM                | - 43 GBd PDM-64QAM                |
| - Line rate: 512 Gbit/s (20% FEC) | - Line rate: 512 Gbit/s (20% FEC) |
| - Fits into 75 GHz ITU slot       | - Fits into 50 GHz ITU slot       |
| - Medium reach: ~1000 km          | - Short reach: ~100 km            |
| - C-Band capacity: ~26 Tbit/s     | - C-Band capacity: ~40 Tbit/s     |

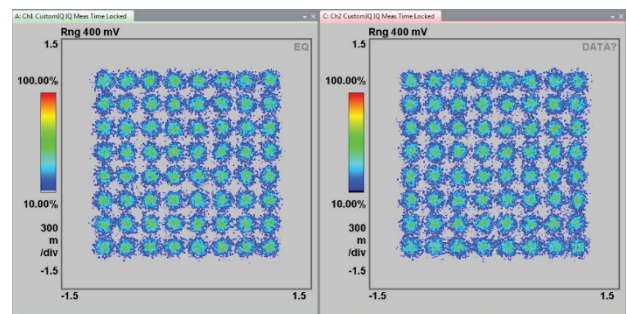
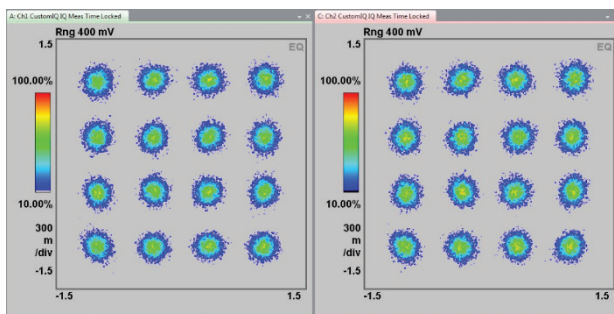



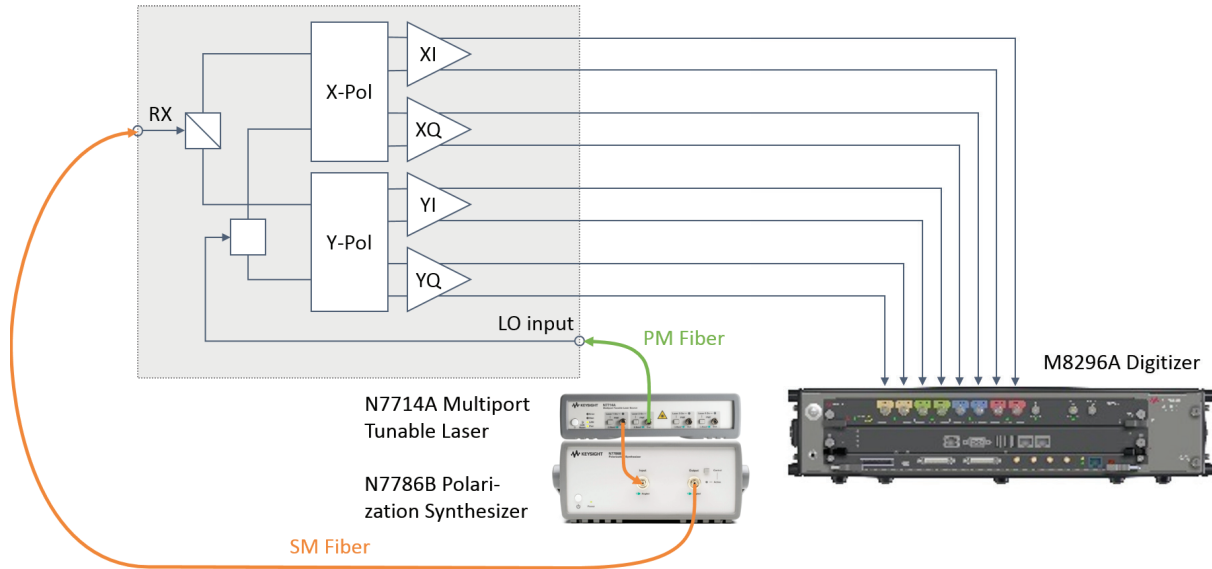

The test of an integrated intradyne coherent receiver (ICR) as defined by Optical Internetworking Forum requires many parameters to test for each device. These devices can be tested in the above illustrated setup quickly and easily. Again the EVM concept offers a powerful tool to verify the overall quality of an ICR within a second. This setup simulates a golden transmitter which has better performance than any production-series transmitter. Analyzing this signal in the same way as a normal

transmitter signal can reveal impairments that reflect the intrinsic performance of the ICR under test (see left screens in the screen shot below) and therefore indicates limitations to the performance that can be achieved.

In addition to the spectral display on the right screens, the image suppression gives you an indication of distortions in the system and shows how well balanced your photodiodes are.

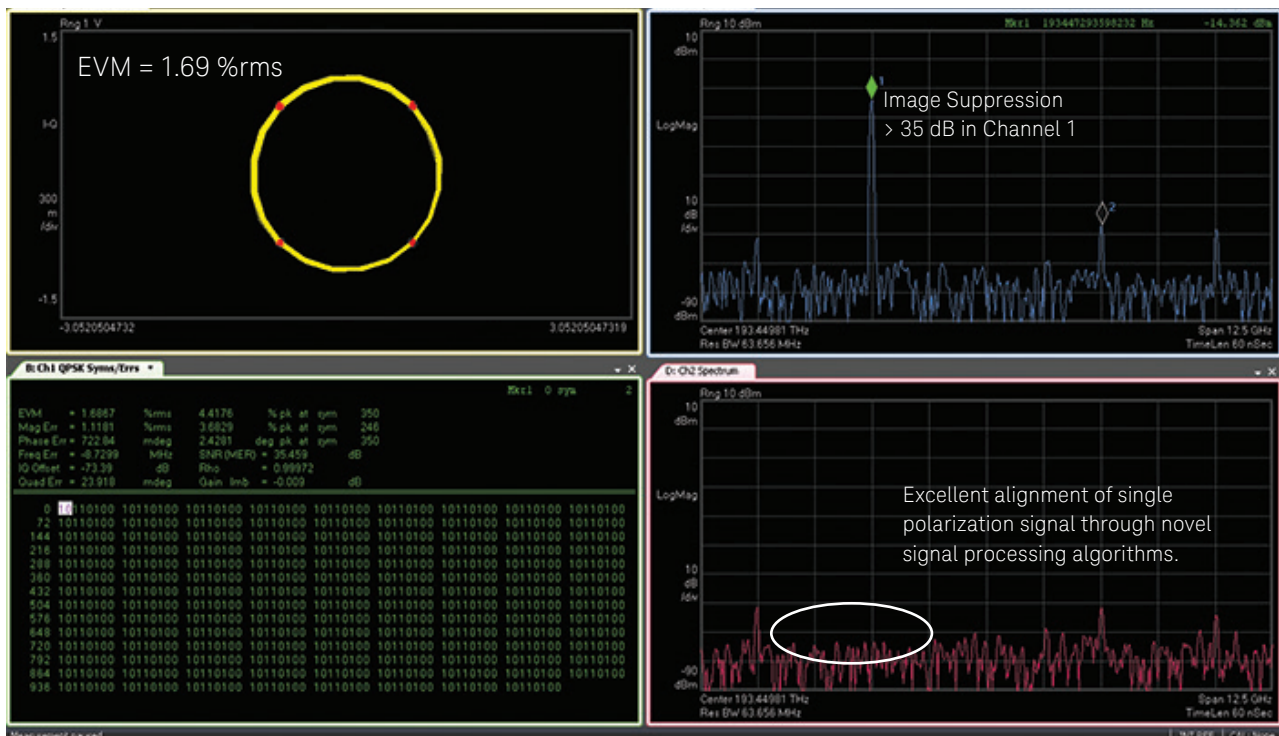

### Integrated coherent receiver test

For detection of complex modulated optical signals OIF defined an electro-optical component typically described as integrated dual polarization intradyne coherent receiver (ICR). This component contains optical and electro-optical components in one package.

The hybrid contains many components that need to be integrated and perform seamless as a black box coherent receiver.

The integrated component needs to be tested in research and in manufacturing.

The M8290A offers an application (M8290430A), to test this kind of devices and extract parameters that characterize the behavior of the component.

With the M8290A it is possible to test the component in an environment that is identical to the final application providing highest confidence in the performance of the component:

This test is performed with the M8290A by generating a beat signal within the detection band to the ICR optical inputs using two continuous wave tunable laser sources.

- This test is an excellent setup to verify the intrinsic performance of the ICR as it reflects noise impairments and all kinds of distortions

- The IQ diagram gives an indication on the noise and the distortion of the signal of the ICR created from a nearly perfect beat signal. The same parameters that are used to quantify the signal quality (EVM, IQ offset, IQ imbalance, Quadrature error) can be used to qualify the intrinsic performance of the component
- Image suppression in a spectral display gives a good indication of presence of imbalances between channels and PIN diodes in the coherent receiver. A good image suppression and large common mode rejection ratio indicate a well balanced receiver

Image suppression is an excellent indication of the presence of potential distortions within the optical receiver. An image suppression in the order  $> 35$  dB indicates high CMRR of well balanced PIN diodes and well de-skewed I-Q channels in the ICR under test.

EVM is an excellent indicator of the overall quality of a complex modulated signal. This concept is applied in that test by creating a beat signal in the ICR and analyzing it in the same way as a complex modulated signal. This emulates a kind of ideal stimulus of the ICR. With this test the EVM can be measured at a single frequency point along the receiver bandwidth of the device under test and within the digitizer bandwidth. This measurement provides additional insight to the device under test, ensuring distortion free measurements at each tested frequency point with good EVM.

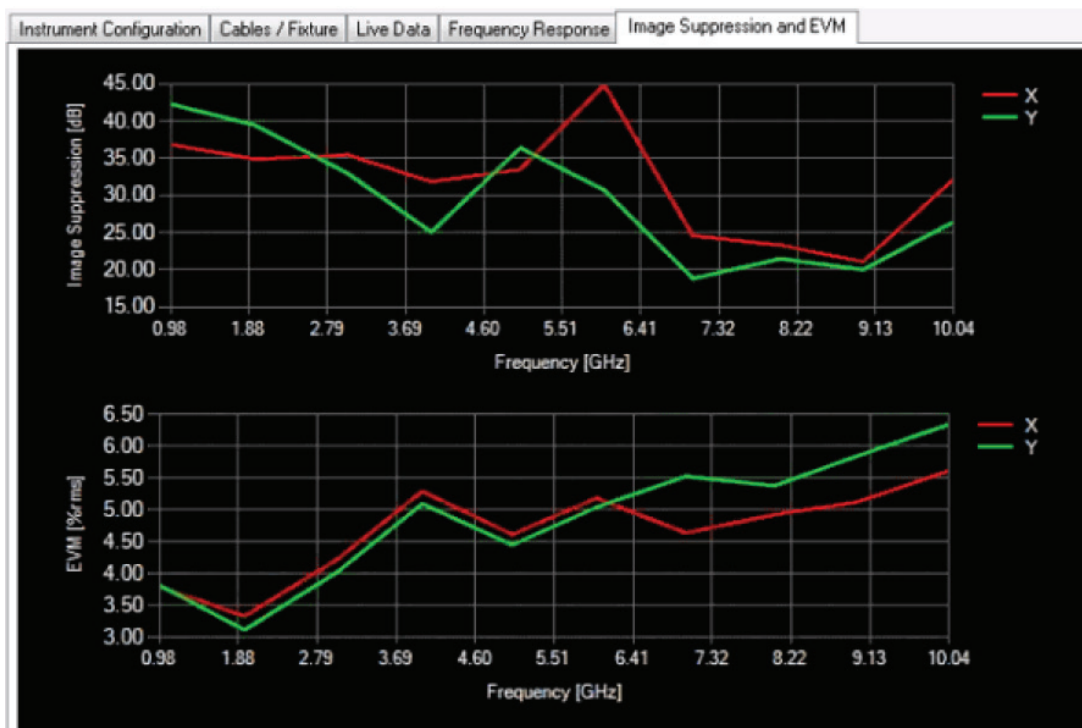



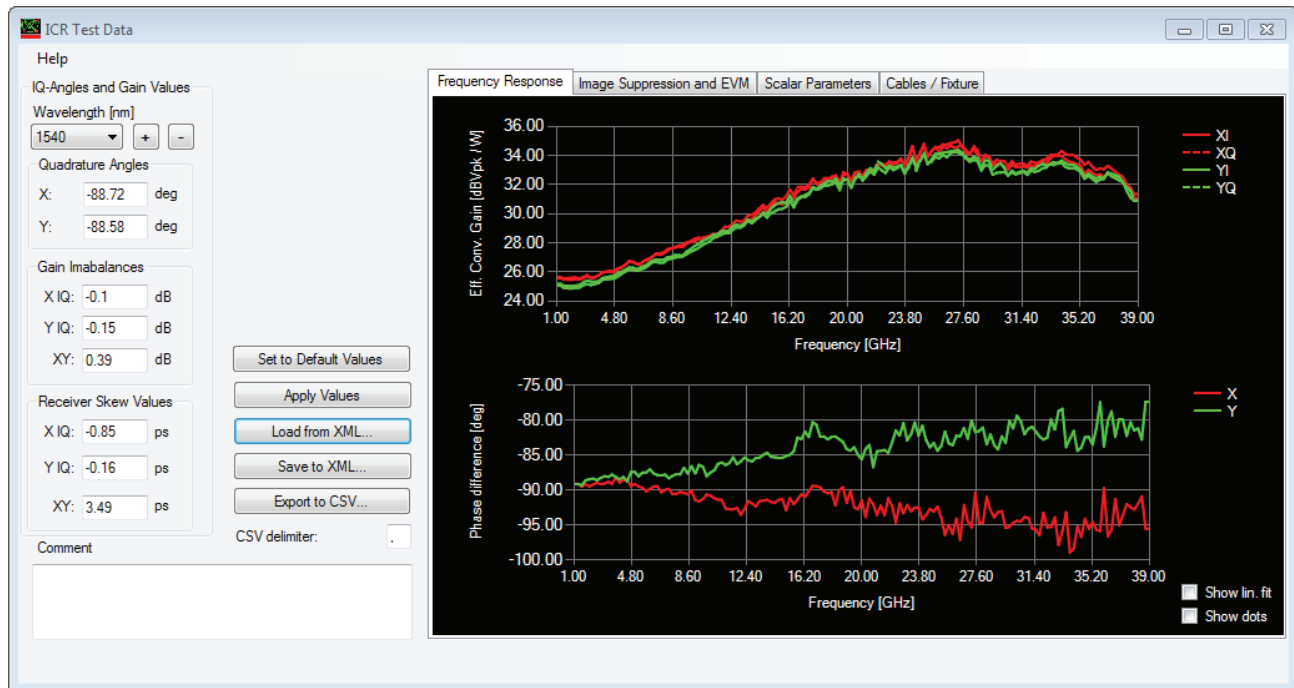

Integrated coherent receiver test provides most relevant test parameters as defined by OIF to characterize integrated coherent receiver components. The following test results are provided by the software:

- Frequency response  $S_{21}(f)$  for each tributary
- Phase difference between I and Q as function of frequency for X and for Y polarization
- Quadrature angles between I and Q for each polarization plane X and Y
- Gain imbalances
- Receiver skew values
- Error vector magnitude (EVM % rms) over frequency (in addition to OIF)
- Image suppression over frequency (in addition to OIF)

NEW

[www.keysight.com/find/oma](http://www.keysight.com/find/oma)

Coherent optical devices such as dual-polarization IQ modulators and intradyne coherent receivers need to be tested in their different development stages as well as qualified by the system integrators. The optionally available coherent optical device test software (M8290440A) provides a turn-key solution for the characterization of these devices. One user interface provides control of all instruments through a single software package. None of the tests requires reconnecting the DUT, saving test time and reducing the uncertainty introduced by connecting and reconnecting the device. The coherent optical device test license provides:

- S21 magnitude responses for XI, XQ, YI, and YQ
- S21 phase responses for XI, XQ, YI, and YQ
- IQ skew for X and for Y polarization
- XY skew
- Receiver IQ angle for X and for Y polarization (requires a two-laser setup)



The test is based on generating a broadband multi-tone signal using a Keysight arbitrary waveform generator (AWG), e.g., M8196A. Comparing the received amplitudes and phases of each tone with the known original amplitudes and phases, the frequency and phase response of the device under test (DUT) can be reconstructed as shown in the figure below. From the measured phase response of each tributary, it is possible to calculate the individual group delays as well as the relative skews.

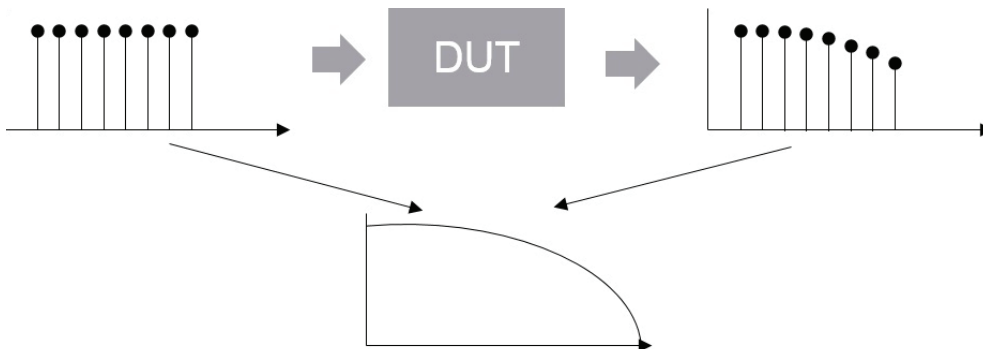



[www.keysight.com/find/oma](http://www.keysight.com/find/oma)

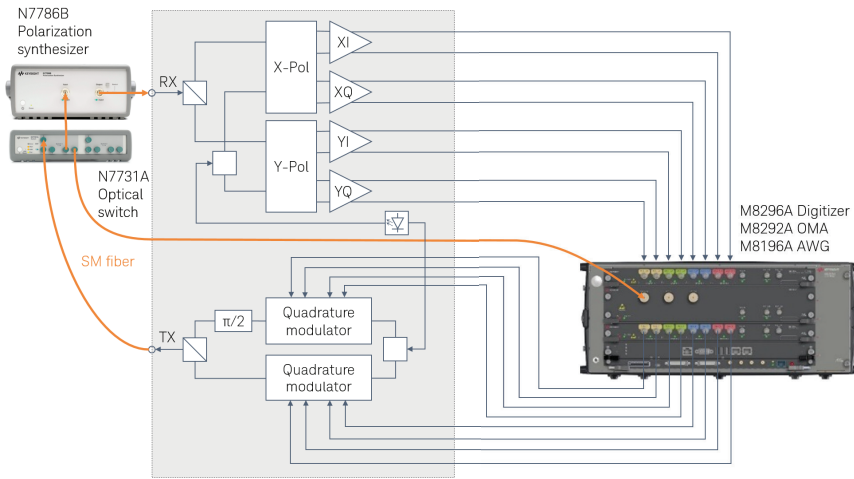

Setup for sequential testing of a device having both transmit and receive functionality, e.g., IC-TROSA, ACO, etc. The transmit-side is re-used after being characterized in the first step to generate the test signal for the receive side.

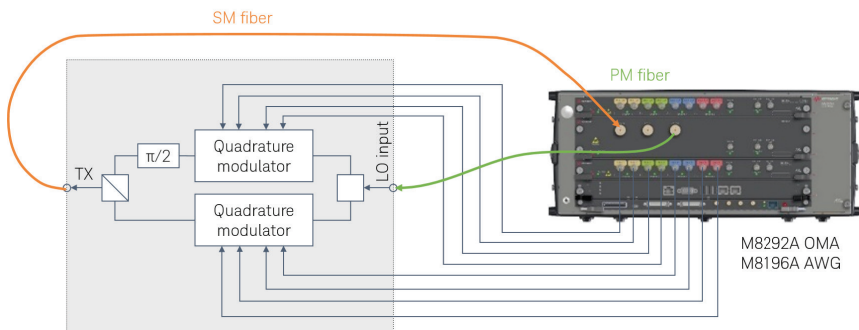

Setup for testing optical IQ modulators. This test can also be used as an in-system calibration measurement. The resulting frequency responses can be exported as S-Parameter files and used for pre-distortion of complexly modulated data signals using QPSK or QAM formats.

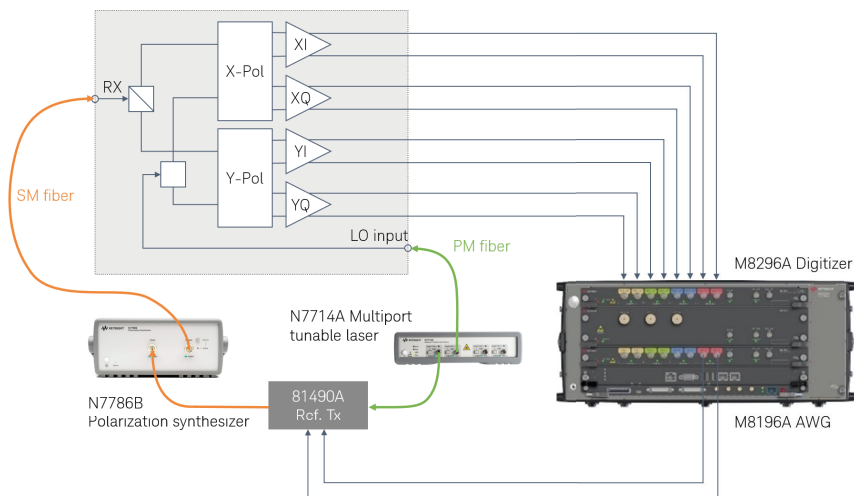

Setup for testing coherent receive devices as for example ICR modules. In contrast to the ICR test application (M8290430A), this test provides additionally the absolute phase response of each receiver path (XI, XQ, YQ and YQ) and allows to derive the respective group delay individually.

# Applications

## Optimizing Manufacturing Test Cost

[www.keysight.com/find/dcac](http://www.keysight.com/find/dcac)

### Introduction

Manufacturers of optical transceivers are faced with increasing challenges to their businesses, particularly how to reduce product cost. Pressures to reduce cost as data rates rise means manufacturing engineering managers and their engineers must be more creative in how to reduce costs before their competitors do. Traditional methods of eliminating tests or trying to make tests run faster may not be feasible, may not yield the intended benefit or may provide results that don't agree well with their customer's measurements. The use of parallel testing promises huge improvements, but more innovation is needed. Read below, how Keysight helps to optimize the manufacturing processes of optical components.

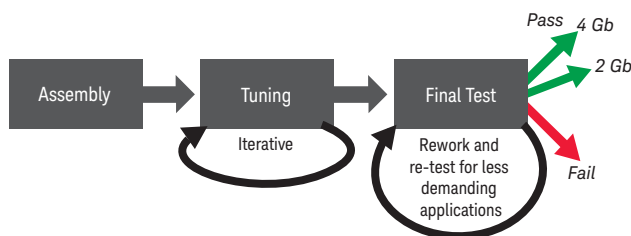

Typical manufacturing flow for simpler and less expensive devices.

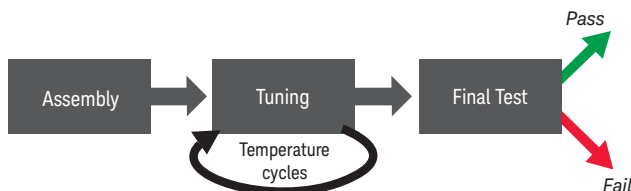

Typical manufacturing flow for more complex devices.

### Common transceiver types and manufacturing flows

The number of communications standards and transceiver types has proliferated during the last decade creating more complexity for the typical manufacturing test facility. Mass market and other high volume transceivers typically have fewer tests and less temperature cycling. More complex transceivers at higher data rates have more extensive tuning, temperature cycling and challenges to meet high desired yields.

The ultimate goal of Keysight's approach is to provide a sufficiently accurate answer, very quickly, which is enabled by these recently introduced capabilities:

- DCA with parallel characterization of multiple devices, or characterization of parallel optics, Improved autoscale performance, eye tuning, rapid eye, faster eye mask testing
- Multi-channel BERTs for characterizing multi-channel devices and multi-channel standards (4 x 25 G)
- Great improvements in cost of test are achieved by testing multiple transceivers in parallel, either several single channel transmitters at once or several channels on a multi-channel transmitter
- Multi-port optical attenuator with up to four separate attenuators that are settable in parallel and provide fast settling times, a significant improvement in both multi-device and multi-lane testing
- Newly designed attenuation devices that ensure high modal fidelity in multimode fiber based transceiver testing, a contribution to narrower test margins and thus better yield

Implementing these innovations in your production line can improve by 2X to 10X the number of units tested per station per year, and result in a 2X to 5X improvement in the cost-of-test per transmitter.

### Characteristics for common optical communications standards

Standards	Package types	Channel rates, Gb/ s	Optical transmitters
<ul style="list-style-type: none"> <li>- 4X Fiber Channel</li> <li>- SONET/SDH to OC-48</li> <li>- Gigabit Ethernet</li> <li>- Wireless CPRI</li> <li>- Passive optical network</li> </ul>	SFP, SFF and PON	0.155 to 6.25	1
<ul style="list-style-type: none"> <li>- 16G Fibre Channel</li> <li>- 10 Gb and 40 Gb Ethernet</li> </ul>	SFP+ and XFP	4 to 14	1
<ul style="list-style-type: none"> <li>- 10 Gb, 40 Gb and 100 Gb Ethernet</li> <li>- 32G Fibre Channel</li> <li>- SONET OC-192</li> </ul>	QSFP, and CFP	10 to 29	4, 8, 10, 12
<ul style="list-style-type: none"> <li>- 400 Gb Ethernet</li> <li>- 64G Fibre Channel</li> </ul>			



For 16x Fibre Channel (16 GFC) for transceiver testing

There are three topologies in this type of network including point-to-point, arbitrated loop, and switched fabric. The connections between devices use transceivers for optimization. For example, in a switched fabric topology, SFP+ (8 GFC and 16 GFC), XFP (10 Gb/s) and SFP ( $\leq 4$  Gb/s) are types of transceivers that connect between the switched fabric and various devices such as storage and computing equipment. Typical patterns used to test transceiver devices include PRBS series, JSPAT, and K28 series which are part of the preloaded library of patterns in the N4960A 32 G BERT.

For 16 GFC applications (14.025 Gb/s), the N4960A can perform BER measurements and can provide a stressed pattern generator signal for receiver tests. 16 GFC devices must be accurately characterized to strict tolerances. The N4960A, used with the N4980A multi-instrument BERT software, can also provide jitter tolerance tests for accurate characterization.

A basic configuration using the 17 Gb/s BERT system is shown above. N4951A-P17 and N4952A-E17 can be loaded with common stress patterns for 16 GFC. You can also custom design your own patterns up to 8 Mb in length and upload them into the N4951A-P17 and N4952A-E17.

The figure above shows a typical hardware setup followed by a procedure showing settings for performing a BER test.

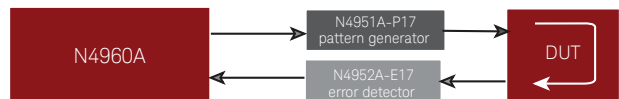

Test setup for 16 GFC

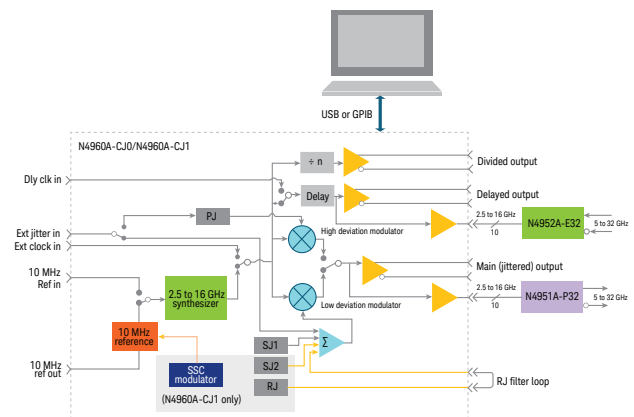

Block diagram (32 Gb/s system)

# Applications

## Communications Waveform Measurements

[www.keysight.com/find/dcax](http://www.keysight.com/find/dcax)

### Application overview

For any high-speed communications signal, the channel and basic signal characteristics must be assessed for compliance with standards and interoperability with other devices in the system path. Digital Communications Analyzers (DCA's) based on wide bandwidth sampling oscilloscopes are recognized as the industry standards for accurate analysis of optical waveforms in R&D, device validation and volume transceiver manufacturing. In addition to basic eye-diagram and pulse waveform characterization, DCA's perform advanced jitter analysis and channel impedance characterization.

### Transmitter compliance testing and eye-diagram analysis

Viewing the eye-diagram is the most common method to characterize the quality of a high-speed digital transmitter signal. Industry standards such as SONET, SDH, Fibre Channel and Ethernet rely on eye-diagram analysis to confirm transmitter specifications. The eye is examined for mask margin, amplitude, extinction ratio and overall quality. Tests are commonly performed using a well defined reference receiver to provide consistent results both in manufacturing test, incoming inspection, and system level applications. Standards based reference receivers and test procedures are built into the DCA's to provide compliance test capability.

In these standard tests automatic histogram analysis determines signal levels to derive key waveform parameters including but not limited to:

- Extinction ratio: How efficiently laser power is converted to information power
- Optical modulation amplitude (OMA): A measure of modulation power
- Eye height and width: An indication of how open the eye is
- One and zero levels: The logic levels of the eye
- Signal to noise ratio: Signal strength compared to noise
- Duty cycle distortion and crossing percentage: A measure of eye symmetry
- Basic peak-to-peak and RMS jitter: A measure of the timing stability of the signal

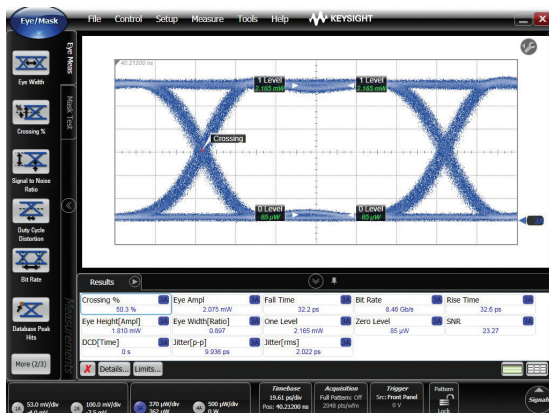

Parameters are automatically derived from the eye-diagram

For eye mask testing industry defined masks are compared to the transmitter eye-diagram. Pass/Fail is quickly determined. Mask margins can be automatically determined. Eye mask test to industry defined hit ratios (a relatively new concept defined as the allowed number of hits compared to the total number of waveform samples) is also automatically performed. Eye mask tests are almost always performed using a reference receiver. A reference receiver defines the entire measurement system to have a specific low pass frequency response, the most common being a fourth-order Bessel low-pass response with the -3 dB frequency at 75% of the data rate.

For example, a 10 Gb/s reference receiver would have a 7.5 GHz bandwidth. A reference receiver allows the waveform to be viewed closer to what a receiver in an actual communications system would see.

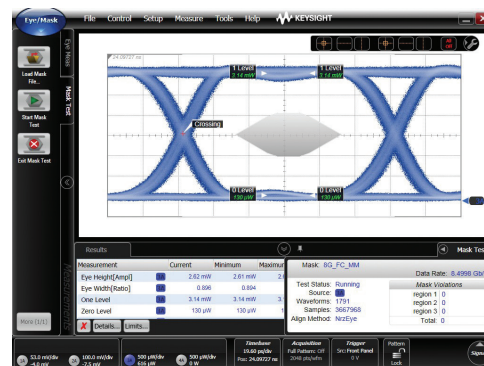

Eye mask tests are performed with a reference receiver based test system

Newer industry standards also employ multi-level signaling formats such as Pulse Amplitude Modulation 4-Level (PAM4). Existing DCA hardware can be used together with new PAM4 Analysis software to analyze optical and electrical PAM4 signals quickly and accurately. Key optical PAM4 parameters characterized by the DCA include:

- Transmitter dispersion and eye closure penalty (TDECQ)
- Outer optical modulation amplitude (Outer OMA)
- Outer extinction ratio (Outer ER)

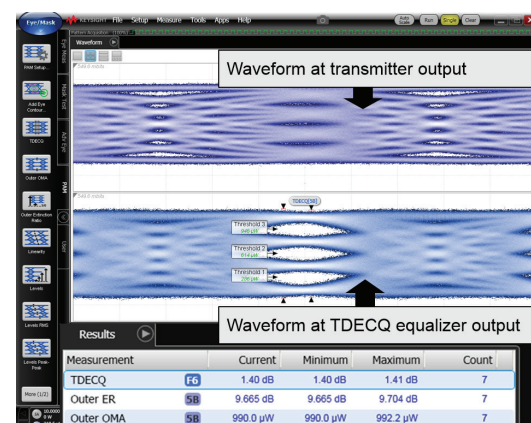

PAM4 analysis software quickly and accurately performs key optical measurements such as TDECQ, Outer OMA, and ER.



[www.keysight.com/find/dcac](http://www.keysight.com/find/dcac)

### Waveform measurements

Not all waveform measurements of optical signals are performed with a reference receiver. The filtering can be switched out to provide a wider bandwidth measurement system. The unfiltered properties of the waveform are accurately observed. The transmitter output may be viewed as an unfiltered eye, or as a pulse train depending on how the DCA is triggered. A DCA can be placed in 'pattern lock' mode to view the individual bits of a digital communications signal allowing a simple analysis of the waveform quality including parameters such as rise and fall times, pulsewidth and overshoot. In 'pattern lock' mode a complete single-valued waveform record, up to  $2^{23}$  bits long, can be recorded for off-line analysis. Advanced signal processing is available with the 86100D (see pages 31 to 36).

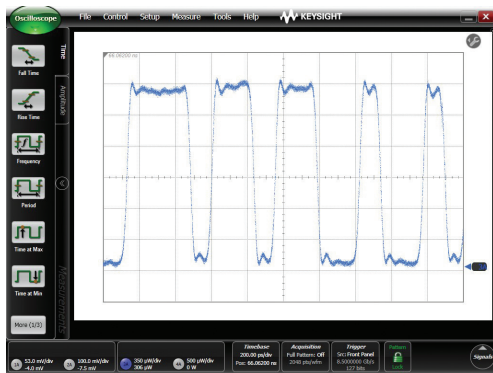

Individual bits can be observed in a 'pattern lock' display

Typically an external timing reference is used to synchronize the oscilloscope to the test signal. In cases where a trigger signal is not available or when required for a standards compliance measurement, clock recovery modules or clock recovery instruments are available to derive a timing reference directly from the waveform to be measured. Clock recovery not only provides a convenient method to synchronize the oscilloscope, it can also control the amount of jitter displayed. Clock recovery effectively creates a high-pass effect in the jitter being observed on the oscilloscope. The clock recovery system loop bandwidth defines the filtering range (see Keysight Product Note 86100-5).

### Jitter analysis

Every high-speed communications design faces the issue of jitter. When data are jittered from their expected positions in time, receiver circuits can make mistakes in trying to interpret logic levels and BER is degraded. As data rates increase, jitter problems tend to be magnified. For example, the bit period of a 10 Gb/s signal is only 100 picoseconds. Signal impairments such as attenuation, dispersion and noise can cause the few picoseconds of timing instability to create eye closure that can mean the difference between achieving or failing to reach BER objectives. The problem is further aggravated by the difficulty presented in making accurate measurements of jitter. A variety of measurement approaches exist but there has been frustration within the industry around the complexity of setting up a measurement, getting repeatable results and the inconsistency of different techniques.

The "equivalent time" sampling oscilloscope, with configurations having over 120 GHz of bandwidth and extremely low levels of intrinsic jitter, is the most accurate tool available for jitter measurements at high data rates.

In many communications systems and standards, specifying jitter involves determining how much jitter can be on transmitted signals. Jitter is analyzed from the approach that for a system to operate with very low BER's (one error per trillion bits being common), it must be characterized accurately at corresponding levels of precision. This is facilitated through separating the underlying mechanisms of jitter into classes that represent root causes. Specifically, jitter is broken apart into its random and deterministic components. The deterministic elements are further broken down into a variety of subclasses. With the constituent elements of jitter identified and quantified, the impact of jitter on BER is more clearly understood which then leads to straightforward system budget allocations and subsequent device/component specifications. Breaking jitter into its constituent elements allows a precision determination of the total jitter on a signal, even to extremely low probabilities.

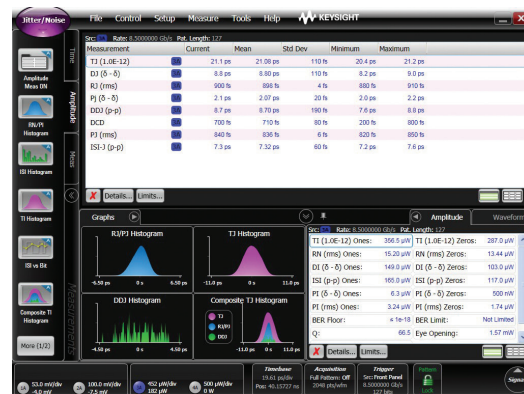

Advanced analysis identifies sources of jitter

### Time domain reflectometry and transmission

Most optical devices have high-speed electrical input and output paths. High signal integrity is achieved with well designed signal paths. DCA's can also be configured as time domain reflectometers (TDR) to easily determine the transmission and reflection properties of electrical channels. This information can be presented as a function of time or frequency as S-parameters. Most new circuit designs are differential to improve crosstalk and interference performance. Circuits need to be characterized in single-ended, differential signal and common signal configurations.

The TDR module sends a fast edge along the transmission line, then analyzes the reflected signal and displays voltage or impedance versus distance. This information can also be converted into the frequency domain to display return loss, VSWR or reflection coefficient versus frequency. Any selected portion of the trace can also be assessed for the excess inductance or capacitance, allowing the designer to estimate the amount of required compensation in that region.

### Addressing the next challenges

The next generation computer and communication systems now being developed will handle data rates of hundreds of gigabits/second. Many systems will incorporate processors and SERDES chip sets that exceed GigaHertz clock frequencies.

New and troubling input/output issues are emerging as switches, routers, server blades, and storage area networking equipment moving toward 100 Gbps data rates. Digital design engineers choosing chip-to-chip and backplane technologies for these systems are finding signal integrity challenges that have not been encountered before.

### The problem with traditional parallel bus topologies

Traditional parallel bus topologies are running out of bandwidth. As parallel busses become wider, the complexity and cost to route on PC boards increase dramatically.

The growing skew between data and clock lines has become increasingly difficult to resolve within parallel busses.

### The solution is fast serial channels

The newer serial bus structure is quickly replacing the parallel bus structure for high-speed digital systems. Engineers have been turning to a multitude of gigabit serial interconnect protocols with embedded clocking to achieve the goal of simple routing and more bandwidth per pin.

### However, these serial interconnects bring their own set of problems

In order to maintain the same total bandwidth as the older parallel bus, the new serial bus needs to increase its data rate. As the data rate increases through serial interconnects, the rise time of the data transition from a zero logic level to a one logic level becomes shorter. This shorter rise time creates larger reflections at impedance discontinuities and degrade the eye diagram at the end of the channel.

As a result, physical layer components such as printed circuit board traces, connectors, cables, and IC packages can no longer be ignored. In fact, in many cases, the silicon is so fast that the physical layer device has become the bottleneck.

### Move to differential transmission lines

In order to maintain signal integrity throughout the complete channel, engineers are moving away from single-ended circuits and now use differential circuits. The differential circuit provides good Common Mode Rejection Ratio (CMRR) and helps shield adjacent PCB traces from crosstalk. Properly designed differential transmission lines will minimize the undesirable effect of mode conversion and enhance the maximum data rate throughput possible.

Unfortunately, differential signaling technology is not always an intuitive science. Differential transmission lines coupled with the microwave effects of high-speed data have created the need for new design and validation tools for the digital design engineer.

Understanding the fundamental properties of signal propagation through measurement and post-measurement analysis is mandatory for today's leading edge telecommunication and computer systems. The traditional Time Domain Reflectometer (TDR) is still a very useful tool, but many times the Vector Network Analyzer (VNA) is needed for the complete characterization of physical layer components.

There is a strong need for a test and measurement system that will allow simple characterization of complex microwave behavior seen in high speed digital interconnects.

### Frequency domain layer measurements and compliance

In fact, many digital standards groups have now recognized the importance of specifying frequency domain physical layer measurements as a compliance requirement.

Both Serial ATA and PCI Express® have adopted the SDD21 parameter (input differential insertion loss) as a required measurement to ensure channel compliance (Figure 3). This parameter is an indication of the frequency response that the differential signal sees as it propagates through the high-speed serial channel. An example of a proposed SDD21 compliance mask is shown in Figure 5 for the Channel Electrical Interface (CEI) working group for the Optical Internetworking Forum (OIF).

Furthermore, new metrics such as Channel Operating Margin are creating the next generation of compliance testing for the complete channel from TX to RX."

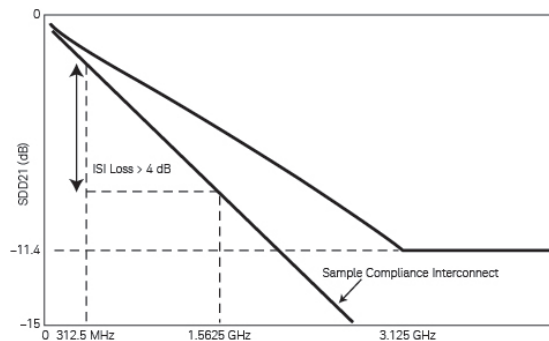

Today's digital standards are now using frequency domain measurements for compliance testing, such as this input differential insertion loss (SDD21) mask for XAUI.



# Why is Physical Layer Testing Required? (Cont.)

[www.keysight.com/find/plts](http://www.keysight.com/find/plts)

## A single test system can provide the total view

As the combination of both time-domain and frequency domain analysis becomes more important, the need for multiple test systems becomes difficult to manage. A single test system that can fully characterize differential highspeed digital devices, while leaving domain and format of the analysis up to the designer, is a very powerful tool.

## Keysight's Physical Layer Test System (PLTS) is designed specifically for this purpose.

PLTS has been designed specifically for signal integrity analysis. PLTS software guides the user through hardware setup and calibration, and controls the data acquisition. It automatically applies patented transformation algorithms to present the data in both frequency and time domains, in both forward and reverse transmission and reflection terms, and in all possible modes of operation (single-ended, differential, and mode-conversion). A powerful virtual bit pattern generator feature allows a user-defined binary sequence to be applied to the measured data to convolve eye pattern diagrams. Next, highly accurate RLCG 1 models can be extracted and used to enhance the accuracy of your models and simulations.

## PLTS provides design confidence through complete characterization

Physical-layer structures have increasingly become the bottleneck in high-speed digital system performance. At low data rates, these interconnects are electrically short. The driver and receiver are typically the biggest contributors to signal integrity. But as clock speeds, bus speeds, and link speeds all push past the gigabit-per-second mark, physical layer characterization becomes more critical.

Another challenge for today's digital designers is the trend to differential topologies. Fully understanding device performance requires analysis in all possible modes of operation.

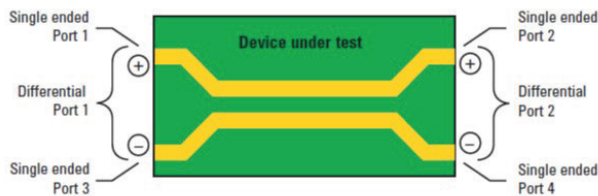

A differential structure operates in many modes. Singleended analysis can reveal sources of asymmetry on this differential transmission line.

Time-domain analysis is typically used for characterization of these physical-layer structures, but often, the designer concentrates only on the intended modes of operation. For a complete time-domain view, step and impulse responses in reflection and transmission (TDR and TDT) must be seen. The analysis must include the unintended modes of operation as well.

Frequency-domain analysis, again in all possible modes of operation, is also necessary for fully characterizing these physical-layer structures. The s-parameter model describes the analog behavior exhibited by these digital structures. This behavior includes reflections from discontinuities, frequency dependent losses, crosstalk, and EMI performance.

For translating device performance into standards compliance, eye diagrams add an important statistical analysis. And for leveraging this complete characterization into improved simulations, measurement-based s-parameter or RLCG<sup>1)</sup> model extraction completes the picture.

Mode	Time domain		Frequency domain	
	TDR	TDT	Reflection	Transmission
Differential	TDD11	TDD21	SDD11	SDD21
	TDD22	TDD12	SDD22	SDD12
Diff-to-comm	TCD11	TCD21	SCD11	SCD21
	TCD22	TCD12	SCD22	SCD12
Comm-to-diff	TDC11	TDC21	SDC11	SDC21
	TDC22	TDC12	SDC22	SDC12
Common	TCC11	TCC21	SCC11	SCC21
	TCC22	TCC12	SCC22	SCC12
Single-ended	T11	T21 T31 T41	S11	S21 S31 S41
	T22	T12 T32 T42	S22	S12 S32 S42
	T33	T13 T23 T43	S33	S13 S23 S43
	T44	T14 T24 T34	S44	S14 S24 S34

Complete characterization includes forward and reverse transmission and reflection, in all possible modes of operation, in both frequency and time domains.

1. An RLCG equivalent circuit model, also known as Telegrapher's Parameters, describes the electrical behavior of a passive transmission line. The model is a distributed network consisting of series resistance and inductance (R and L) and parallel capacitance and conductance (C and G).

### PLTS enables mode-conversion analysis for early insight into EMI problems

The benefits of differential signaling include lower voltage swings, immunity from power supply noise, a reduced dependency on RF ground, and improved EMI performance (reduced generation and susceptibility). The extent to which a device can take advantage of these benefits is directly related to device symmetry.

#### Symmetric devices

Symmetric devices only respond to, and only generate, differential signals. These ideal devices do not respond to or generate common-mode signals, and they reject radiated external signals (i.e., power supply noise, harmonics of digital clocks or data, and EMI from other RF circuitry).

#### Asymmetric devices

Asymmetric devices however, do not exhibit these benefits. When stimulated differentially, an asymmetric device will produce a common-mode response in addition to the intended differential response, and cause EMI radiation.

Conversely, with a common-mode stimulus, an asymmetric device will produce an unintended differential response. This mode conversion is a source of EMI susceptibility. Mode-conversion analysis is an important tool for understanding and improving device symmetry, and provides the designer with early insight to identify and resolve EMI problems at the design stage.

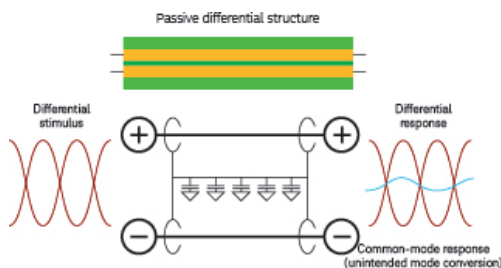

Asymmetric devices cause mode-conversions, which are indicators of EMI generation and susceptibility.

#### Mode conversion - A practical application

A practical application of how mode conversion helps identify problems in physical layer devices is shown in Figure 7. This shows a XAUI backplane with two daughter cards that typically transmit data at 3.125 Gbps.

The design objective for this high-speed differential channel is to minimize the crosstalk between adjacent differential PCB traces throughout the length of the channel. The channel consists of the linear passive combination of the backplane and two daughter cards. Any mode conversion from differential mode to common mode will generate EMI and create crosstalk that will be incident upon other channels and will degrade performance. However, locating the exact structure within the channel that creates the most mode conversion is not simple.

Looking at Figure below, the differential to common mode conversion time domain reflection parameter (TCD11) is time aligned with the differential impedance profile of the channel (TDD11) below it. A marker is placed on the largest magnitude peak of TCD11. This is where the physical structure within the channel is creating the most mode conversion and thus the source of the most crosstalk.

We can align the TDD11 to the TCD11 in time and therefore co-locate the problematic structure on TDD11. To relate this structure to the channel, we use the differential impedance profile as a reference. From previous analysis, we know that the two capacitive discontinuities on TDD11 are the daughter card via field and motherboard via field, respectively.

Since the marker falls upon the second discontinuity on TDD11, it is deduced that the motherboard via field is the biggest culprit to causing crosstalk in adjacent channels. The motherboard via field was subsequently rerouted and the crosstalk generation was reduced considerably. This shows how identifying the mode conversion in a channel can be intuitive with proper analysis.

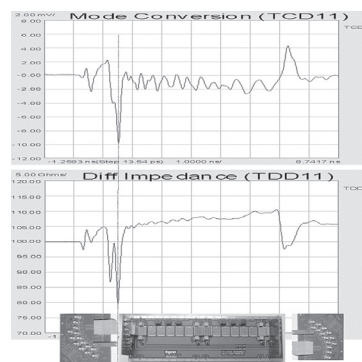

By aligning the impedance profile with the mode conversion profile, PLTS allows the pinpointing of crosstalk-generating structures within physical layer devices.

#### Remove unwanted effects from the measurement

##### Error correction

Over the years, many different approaches have been developed for removing the effects of the test fixture from the measurement (shown in Figure 11). The level of difficulty for each error correction technique is linearly related to the accuracy of each method. Time domain gating is perhaps the simplest and most straightforward method, but it is also the least accurate. Likewise, de-embedding is the most complicated method, but it is the most accurate. It is important to have a test system that will allow flexibility of choosing the method of error correction desired for each application.

Error correction techniques fall into two fundamental categories: direct measurement (pre-measurement processing) and de-embedding (post-measurement processing). Direct measurement requires specialized calibration standards that are connected to the end of a coaxial test cable and measured. The accuracy of the device measurement relies on the quality of these physical standards. De-embedding uses a model of the test fixture and mathematically removes the fixture characteristics from the overall measurement. This fixture de-embedding procedure can produce very accurate results.

## Various Error Correction Techniques

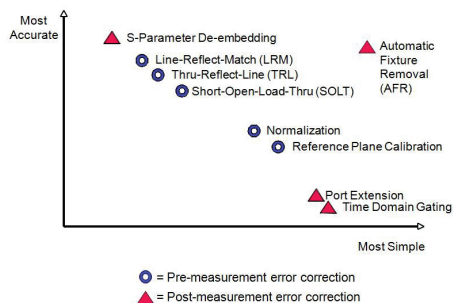

PLTS has advanced error correction techniques to allow flexibility for many applications.

### Port Extension

Port Extension (also known as Phase Rotation) mathematically extends the calibration reference plane to the DUT. This technique is easy to use, but assumes the fixture – the unwanted structure – looks like a perfect transmission line: a flat magnitude response, a linear phase response, and constant impedance. If the fixture is very well designed, this technique can provide good results. Because gating essentially considers the magnitude of the unwanted discontinuity, and Port Extensions consider phase (electrical length), using the two tools together may provide optimum results.

### Time-domain gating

Time-domain gating (see figure) is similar to port extension, in that it is also very easy and fast. The user simply defines two points in time or distance, and the software mathematically replaces the actual measured data in that section with data representing an “ideal” transmission line. The return loss is then recalculated to show the effects of the change in the frequency domain.

One practical application of time-domain gating is as a confidence check before replacing a suspect connector. Figure 14 illustrates how this technique might be used.

De-embedding (see figure at the right/middle) uses an accurate linear model of the fixture, or measured s-parameter data of the fixture. This fixture data can then be removed mathematically from the DUT measurement data in post-processing.

Calibration at the DUT reference plane has the advantage that the precise characteristics of the fixture do not need to be known beforehand, as they are measured and corrected for during the calibration process.

An example of this technique is microprobing using a calibration substrate, where the calibration reference plane is established at the probe tips, rather than at the end of the coaxial test cables. Advanced calibration techniques (TRL/LRM) – originally developed for wafer probing applications – provide additional options.

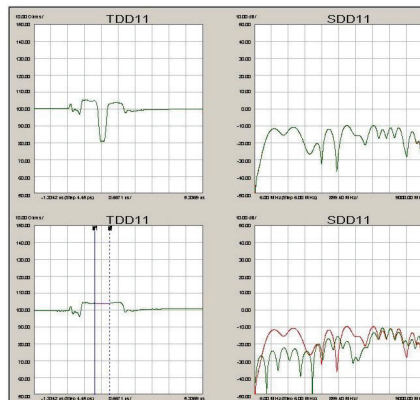

In this rather extreme example of time-domain gating, the top plots show the measured differential step impedance and return loss. The lower left plot shows a gate added to remove the large discontinuity in the center of the trace. On the lower right, the measured and the recalculated return losses are displayed. In this case, the gate improved the return loss by more than 10 dB within the frequency band of interest.

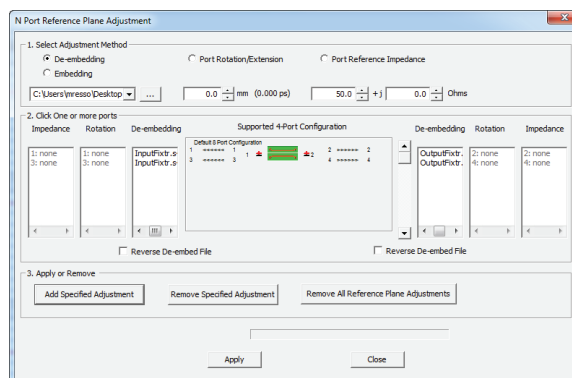

The effects of test fixtures can be removed from the device in post-processing through de-embedding.



A microprobing application, where the calibration is performed using an impedance standard substrate, establishes the calibration reference plane at the probe tips.

## Applications

### Lightwave Component Analysis

[www.keysight.com/find/lca](http://www.keysight.com/find/lca)

In digital photonic transmission systems, the performance is ultimately determined by Bit Error Ratio Test (BERT). As this parameter describes the performance of the whole system, it is necessary to design and qualify subcomponents like modulators, PIN detectors and PIN-TIAs, which are analog by nature, with different parameters that reflect their individual performance.

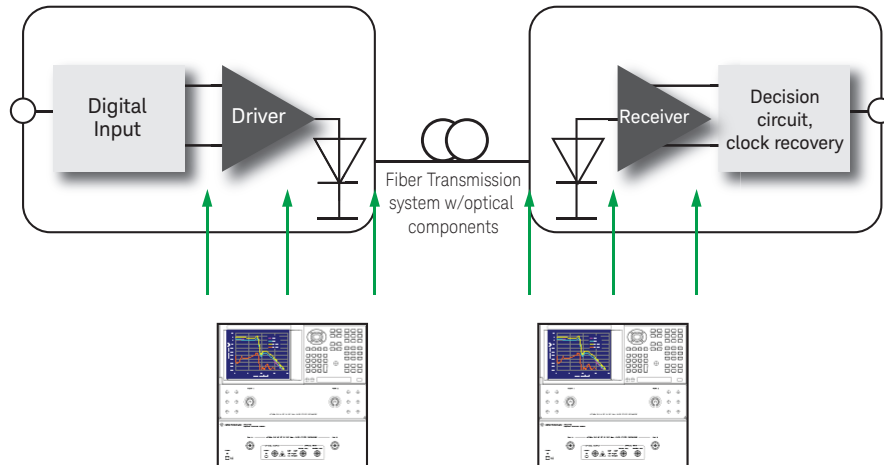

These components significantly influence the overall performance dependant of modulation frequency system with the following parameters:

- 3 dB bandwidth of the electro- optical transmission
- Relative frequency response, quantifying how the signal is transformed between optical and electrical connection
- Absolute frequency response, relating the conversion efficiency of signals from the input to the output
- Electrical reflection at the RF port
- Group delay of the opto-electronic component to qualify the distortion caused by frequency dependent delay

In many cases it is necessary to qualify the lab prototype of a receiver or transmitter for manufacturing. In this case the device under test needs to be characterized under various environmental and operating conditions. With the SCPI or .NET based remote control this task can be automatized to verify the optimal working conditions of the device. In the following manufacturing process each device can be characterized using this automated control of the LCA via LAN.

#### O/E characterization

The measurement of an electro-optical receiver device consists of the ratio of output electrical modulation current to input optical modulation power. Responsivity for OE devices described how a change in optical power produces a change in electrical current. Graphically this is shown in the figure below.

The LCA measures the input optical modulation power and output modulation current and displays the ratio of the two in Amps/Watt.

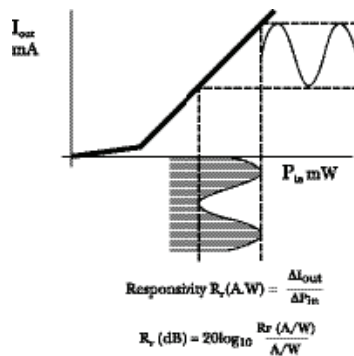

#### E/O characterization

The measurement process for EO devices is similar to OE devices. The measurement of an EO transmitter is a combination of input modulating current and output optical modulation power. Slope responsivity is used to describe how a change in input current produces a change in optical power. Graphically this is shown in the figure below.

An LCA measures input modulating current and output modulation power and displays the ratio of the two in Watts/Amp, either linearly or in decibels.

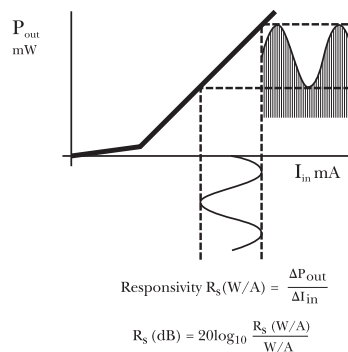

[www.keysight.com/find/n7700](http://www.keysight.com/find/n7700)

## The N7700A Photonic application suite

- Display and overlay of traces from multiple channels and multiple measurement files
- Scale switching between wavelength and frequency
- Display of tabular analysis
- Smoothing, markers and zooming
- File loading, saving and data export
- Direct launching of Excel and Matlab with data

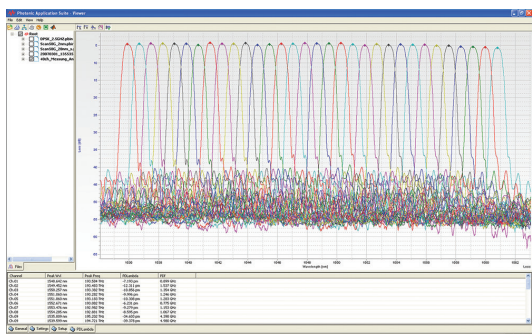

The N7700A Photonic Application Suite is a modular software platform for fast, easy and advanced characterization and analysis of optical components and signals. This suite is widely distributed with instruments and from the Keysight website and can be installed on PCs to control instruments and to process and analyze measurement data.

The freely-distributed main package of the N7700A Photonic Application Suite provides a powerful File Viewer program that allows viewing and analyzing measurement data. It has been designed for sharing measurement results throughout entire development teams or manufacturing groups.

The File Viewer uses the same N77xx Windows-based graphical user interface that is used in the measurement engine packages. The controls for this interface can also be built into customized programs for automated data display.

For performing measurement tasks, an increasing range of application packages are available. Some basic ones are available free for use with the instruments. Licenses can be purchased for more advanced packages. All packages can be downloaded and used immediately for a 14 day trial period and 60-day evaluation licenses can also be generated automatically from the Keysight web site for extended consideration.

## Insertion loss

The Insertion Loss measurement package performs very accurate swept- wavelength insertion loss measurements using one of Keysight’s tunable laser sources along with optical power meters. No license required.

## Fast IL/PDL measurement

The Fast IL/PDL measurement package makes rapid and very accurate measurements of spectral insertion loss and polarization dependent loss (PDL) characteristics of multiport optical components. The new single sweep Mueller Matrix method provides speed and immunity from vibrations and noise. Measurements including multiple lasers for wider wavelength coverage and return loss module are now also supported.

In addition to the measured IL and PDL traces, the Mueller Matrix data can be exported and analyzed to provide the polarization resolved IL traces for the device axes (TE/TM). Measurement of optical-to-electrical devices like receiver assemblies is also supported as described on page 11.

The matrix analysis for calculating the IL traces aligned with TE or TM is especially valuable for fast characterization on wafers or chips (integrated photonics), often eliminating the need to directly align and stabilize the polarization launched into the device. License available for purchase as **N7700A-100**.

## Filter analysis

The Filter Analysis package provides extended post-processing of measurements from the IL/PDL and IL measurement packages for analysis of narrow-band components like filters and multiplexers. Analysis parameters include peak and center wavelength, wavelength offset from ITU grid, IL at ITU wavelength and center wavelength, bandwidth and channel isolation from adjacent and non-adjacent channels. From the TE & TM traces of the IL/PDL engine, the polarization dependent frequency shift (PDF or PDλ) of channels in filters, interleavers or phase demodulators can also be determined. A convenient peak search function is also included.

License available for purchase as **N7700A-101**.

## Fast spectral loss measurement

This package measures insertion loss and power spectra at enhanced repetition rate and is a valuable tool for tuning and calibrating devices with near real-time feedback. Especially powerful in combination with the 81606A and 81960A tunable laser using bidirectional sweeps, repetition rates of 1 to 3 scans per second can be attained, depending on the sweep range. This package also provides stitching of scans with multiple power ranges for highest dynamic range. License available for purchase as **N7700A-102**.

## Polarization Navigator

The Polarization Navigator package provides all the tools needed for your work with N778x polarization analysis and control instruments.



## 81600B, 81602A, 81606A, 81607A, 81608A, 81609A Tunable Laser Modules

[www.keysight.com/find/tls](http://www.keysight.com/find/tls)

- Complete wavelength coverage from 1240 to 1650 nm
- High power with low SSE for high dynamic range
- Fast two-way sweeps to reduce test times
- Built-in wavelength meter for optimum tuning precision
- Specified performance in the continuous sweep mode



Single-Box Test solution for swept wavelength characterization

### Keysight 8160xx Family of Tunable Laser Sources

The Keysight 8160xx tunable laser modules fit into the bottom slot of the Keysight 8164B Lightwave Measurement System mainframe.

### The Keysight 81606A Top-Line Tunable Laser Source

The new 81606A Option 216 Tunable Laser Source is the new flagship model, featuring the widest tuning range of 200 nm, and an outstanding dynamic wavelength accuracy and repeatability. The excellent low-SSE performance of better than 80 dB/nm signal-to-source spontaneous emission ratio (signal-to-SSE ratio) and the high signal power permit measurements of wavelength isolation to 100 dB, most often limited by power meter sensitivity.

### The Keysight 81607A, 81608A Value Line Tunable Laser

The new 81607A value line tunable laser source complements the top line 81606A model at a moderately reduced output power. With a typical wavelength repeatability of  $\pm 1$  pm even during two-way sweeps with up to 200 nm/s, it is ideal for high-throughput test and automated adjustment of passive optical components. The new 81608A, another member of the value line tunable laser sources, offers a peak output power of more than +12 dBm, at least 75 dB/nm above its spontaneous emission level. The 81608A features a typical wavelength repeatability of  $\pm 1.5$  pm at two-way sweeps up to 200 nm/s. The laser's balance of features, performance and price makes it suitable for both coherent transmission experiments and cost-effective manufacturing-floor component testing.

### The Keysight 81609A Basic Line Step-Tunable Laser

The new 81609A basic line module can step within 300 milliseconds to discrete wavelengths with a resolution of 0.1 pm and a typical wavelength repeatability of  $\pm 3$  pm, making it ideal for cost-effective testing of broadband optical devices. Like the other modules in the family, it delivers more than +12 dBm peak output power with low spontaneous emission levels. At  $\pm 0.01$  dB power stability over an hour, it can also serve as a static local oscillator with a wide tuning range for receiver testing or transmission experiments.

### Improved O-band models for Silicon Photonics applications

The new 8160xA option 113 covers the wavelength range from 1240 nm to 1380 nm for an important set of applications. Equipped with PMF output fiber, these are a good match for testing and developing components with Silicon Photonics technology. Verifying the spectral responsivity and the sensitivity of receiver optical subassemblies (ROSA) for 100G Ethernet benefit from more than +10 dBm output power - enough to allow for external modulation in BER testing. Combined with very low SSE levels, Option 113 is ideal for testing wavelength filters for LR4 components.

### The Keysight 81602A: An O-band Tunable Laser Source Exceeding 63 mW Output Power

The new 81602A Tunable Laser Source reaches an optical power level of over +18 dBm. The high output power helps compensate for the coupling loss of optical surface probes or the insertion loss of external modulators during the verification of integrated photonic designs. This allows testing photonic devices at relevant signal levels and wavelengths. With a tuning range of 1250 nm to 1370 nm, the laser addresses the latest Silicon Photonics research.

The extra high power tunable laser model extends power budget limits in test setups and speeds fiber or probe alignment by getting first light faster: +18 dBm output power help overcome the limitations of probe coupling efficiency, particularly where surface probes need to operate over a broad wavelength range.

### Characterize filters

A critical aspect of measuring filters to demultiplex wavelengths is the spectral isolation which determines the crosstalk between signals at different wavelengths. The insertion loss should be low for desired wavelengths and high for wavelengths that should be rejected and routed elsewhere.

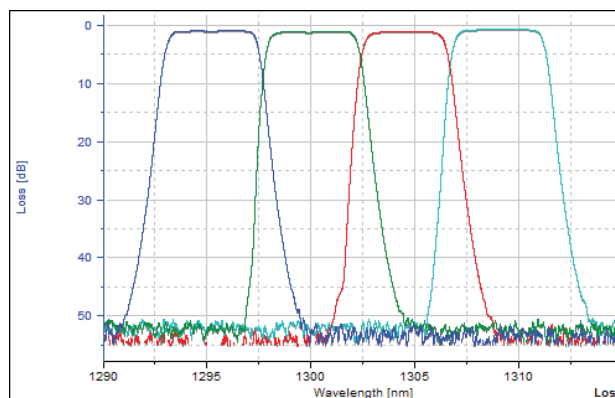



[www.keysight.com/find/tls](http://www.keysight.com/find/tls)

An aspect of lasers that cover wide wavelength ranges is the broadband spectrum of the optical emitter medium. In a laser cavity, most of the emitted power is stimulated at the tuned wavelength, but a natural proportion of broadband source spontaneous emission (SSE) is also produced. Since some of this light will be in the passband wavelengths of a filter, even when the laser line is blocked, a power meter will receive some background light after the filter. This effect is stronger when the passband is wider, like for CWDM filters. This limits the dynamic range for measuring the isolation.

### Low-SSE optical output port

The 81606A features a single optical output with more than +12 dBm output power. It combines the highest power level with the lowest SSE level in the 8160xx product family, 80 dB/nm below the signal. The 81607A comes with +8 dBm peak output power, 81608A and 81609A with more than +12 dBm, 75 dB/nm above their spontaneous emission level. For all 8160xA modules, the output power can be reduced to 0 dBm by the user.

### Realize the cost efficiency and performance benefits in WDM component tests

The testing of optical filters is based on a generic principle, namely the stimulus-response test. The state-of-the-art approach is a wavelength-resolved stimulus-response measurement utilizing a tunable laser source that is capable of fast and precise sweeps across the entire wavelength range, and optical power meters.

For DWDM components, high wavelength accuracy and dynamic range are critical. For CWDM and PON components, a wide wavelength range, dynamic range and tight costing are key targets. If the investment in the test solution can be shared among many different types of filters, the contribution to each individual filter is minimized. In this way, cost targets for CWDM and PON components can be met without sacrificing accuracy. Investing in the Keysight 8160xx Family of Tunable Laser Sources can realize both the cost efficiency and performance benefits required.

Keysight tunable laser module selection table

1240 nm	1360 nm	1460 nm	1530 nm	1565 nm	1625 nm	1675 nm
O-Band	E-Band	S-Band	C-Band	L-Band	U-Band	
<b>Compact, JET, iTLA-based</b>			81950A-310	81950A-301		
			N771xA-340	N771xA-304		
<b>Full-size, ECL-based</b>		81606A-216, , 81608A-216 (200 nm)				
81602A-013		81606A/7A/8A -116 (150 nm)				
		81600B-140, 81600B-142				
81606A-113, 81608A-113						



### An ideal stimulus for DWDM system loading

The Keysight Technologies 81950A compact tunable laser source is step-tunable for setting channel frequencies within any grid in the C- or L-band. With high output power up to +15 dBm, narrow linewidth of 100 kHz, and offset grid fine-tuning capability, the 81950A is a universal source for realistic loading of the latest transmission systems. It is available with C-band or L-band wavelength coverage. The 81950A can reach any wavelength point within its specified wavelength range just like all other Keysight tunable lasers. In this mode, code compatibility with existing test setups based on Keysight's range of tunable lasers is a great asset.

### 81950A Tunable System Source

Wavelength range	1527.60 to 1570.01 nm (196.25 to 190.95 THz, 81950A-310) 1570.01 to 1611.76 nm (190.95 to 186.00 THz, 81950A-301)
Wavelength resolution	Typ. 100 MHz, 0.8 pm at 1550 nm
Maximum tuning speed	< 30 s (incl. power stabilization)
Fine tuning range / resolution	typ. $\pm 6$ GHz / typ. 1 MHz
Absolute wavelength accuracy <sup>1</sup>	$\pm 22$ pm ( $\pm 2.5$ GHz)
Relative wavelength accuracy	$\pm 12$ pm ( $\pm 1.5$ GHz)
Wavelength repeatability	Typ. $\pm 2.5$ pm ( $\pm 0.3$ GHz) <sup>3</sup>
Wavelength stability (typ.) <sup>3</sup>	$\leq \pm 2.5$ pm ( $\pm 0.3$ GHz) over 24 hours, $\leq \pm 2.5$ pm over 15 min
Linewidth, coherence control off	Typ. 100 kHz, SBS suppression off
Maximum output power (continuous power during tuning)	$\geq +13.5$ dBm (typ. $\geq +15$ dBm) Option 310 $\geq +11.5$ dBm (typical $\geq +13$ dBm) Option 301
Power range (nominal)	8 dB off maximum output power
Power stability <sup>3</sup>	Typ. $\pm 0.03$ dB over 24 hours
Power flatness versus wavelength	Typ. $\pm 0.2$ dB (full range)
Power repeatability (typ.)	$\pm 0.08$ dB <sup>3</sup>
Power repeatability (typ.)	50 dB
Signal to source spontaneous emission ratio <sup>4</sup>	Typ. 50 dB/1 nm <sup>2</sup>
Relative intensity noise (RIN) (typ.) <sup>2</sup>	-145 dB/Hz (10 MHz to 40 GHz)
Dimensions (H x W x D)	75 mm x 32 mm x 335 mm

1. At day of calibration.
2. At maximum output power as specified per wavelength range.
3. At constant temperature  $\pm 0.5$  K.
4. Value for 1 nm resolution bandwidth.

### Ordering information

81950A-310	Tunable System Source C-band, step mode
81950A-301	Tunable System Source L-band, step mode

1. All tunable lasers must be ordered with one connector option.
2. # 071 for PMF, straight output (not available for 81960A).
3. # 072 for PMF, angled output.
4. One Keysight 81000xl-series connector interface is required.

[www.keysight.com/find/tls](http://www.keysight.com/find/tls)

## N7711A, N7714A Tunable laser sources

- Compact instrument format with one or four ports per unit on one-half rack-unit width and one-unit height
- Flexible configuration of four-port model between C- and L-band channels (N7714A)
- Adjustable to any wavelength grid (ITU-T 100 GHz, 50 GHz, 25 GHz, and arbitrary grids), or use gridless wavelength setting
- Narrow linewidth less than 100 kHz and offset-grid tuning greater than  $\pm 6$  GHz ideally suited for coherent mixing applications and new complex modulation formats
- Up to +15 dBm output power, with 8 dB power adjustment range
- Polarization maintaining fiber output

The new Keysight N7711A and N7714A tunable lasers are single-port and four-port sources, available with C-band or L-band wavelength coverage. The narrow linewidth and offset grid fine-tuning capability of the N7711A and N7714A make them ideal sources for realistic loading of the latest transmission systems.



N7711A one-port Tunable Laser Source



N7714A four-port Tunable Laser Source

The N7711A and N7714A tunable laser sources are step-tunable within any frequency grid in the C-band (1527.60 to 1570.01 nm; 196.25 to 190.95 THz) or L-band (1570.01 to 1611.76 nm; 190.95 to 186.00 THz). Their output power of up to +15 dBm and a linewidth under 100 kHz are ideal to emulate state-of-the-art DWDM transmitters. SBS suppression can be activated on demand to avoid stimulated Brillouin scattering.

## Tuning modes that fit every application

Each individual laser in the N7711A and N7714A features the same tuning modes as the 81950A: in channel setting mode, the source wavelength, (or frequency, respectively) is determined by the chosen channel index, zero frequency and grid spacing; ITU-T standard grids are possible as well as custom grids. In wavelength setting mode the laser operates gridless and is tunable to any wavelength point within its range, just like any other Keysight tunable lasers. In both modes, each laser channel operates independently and can be fine-tuned by  $\pm 6$  GHz with output power active.

## The 77-Viewer: An easy-to-use graphical user interface

The 77's Window's based graphical user interface offers flexible and extensive control of the instrument.

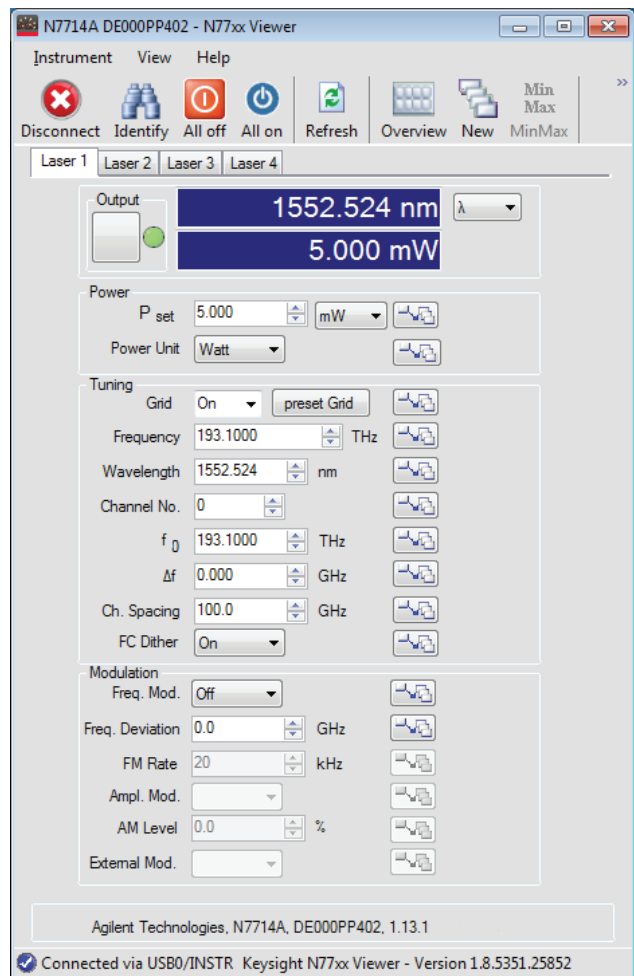

Technical Specifications N7711A and N7714A (Specifications apply to wavelengths on the 50 GHz ITU-T grid, after warm up.)		
Wavelength	Options #310, #322, #340	Options #301, #322, #304
Wavelength range	1527.60 nm to 1570.01 nm (196.25 THz to 190.95 THz)	1570.01 nm to 1611.76 nm (190.95 THz to 186.00 THz)
Fine tuning range	Typ. $\pm 6$ GHz	
Fine tuning resolution	Typ. 1 MHz	
Absolute wavelength accuracy	$\pm 22$ pm ( $\pm 2.5$ GHz)	
Relative wavelength accuracy	$\pm 12$ pm ( $\pm 1.5$ GHz)	
Wavelength repeatability	Typ. $\pm 2.5$ pm ( $\pm 0.3$ GHz)	
Wavelength stability	Typ. $\pm 2.5$ pm ( $\pm 0.3$ GHz), 24 hours	
Tuning time including power stabilization	Typ. < 30 s	
Optical power		
Maximum output power	$\geq +13.5$ dBm Typ. $\geq +15$ dBm	$\geq +11.5$ dBm Typical $\geq +13$ dBm
Power stability	Typ. $\pm 0.03$ dB over 24 hours	
Power flatness	Typ. $\pm 0.2$ dB (full wavelength range)	
Power repeatability	typ. $\pm 0.08$ dB	
Spectral		
Linewidth	Typ. < 100 kHz (SBS suppression off)	
Side mode suppression ratio (SMSR)	Typ. 50 dB	
Source spontaneous emission (SSE)	Typ. 50 dB/ 1 nm Typ. 60 dB/ 0.1 nm	
Relative intensity noise (RIN)	Typ. $-145$ dB/Hz (10 MHz to 40 GHz)	

#### Non-warranted Performance Characteristics N7711A and N7714A

Grid spacing	100, 50, 25 GHz, arbitrary grid, or gridless
Output power	
Power attenuation range	8 dB
Power setting resolution	0.1 dB
Residual output power (shutter closed)	$\leq -45$ dBm
Stimulated brillouin scattering	
SBS suppression FM p-p modulation range	0 to 1 GHz
SBS suppression dither frequency	20.8 kHz

[www.keysight.com/find/oct](http://www.keysight.com/find/oct)

The Keysight 81663A high power DFB laser source modules are best suited for multiple fixed-wavelength test applications, like PON component test.

- Center wavelengths: 1310 nm, 1490 nm, 1510 nm, 1550 nm, 1625 nm
- Fine tuning capability  $\pm 500$  pm
- Excellent power and wavelengths stability
- Up to 20 mW output power



The Keysight 81663A modules offer +13 dBm output power to overcome power penalties given in today's test setups. Their excellent power and wavelength stability is key for accurate testing of IL and PDL at PON wavelengths.

### Applications

- PON component IL & PDL test
- PON Stimulus-response measurement

### 850 nm source

A special option with a nominal center wavelength of 850 nm and multimode fiber output is available upon request.

Keysight 81663A Option	#131	#149	#151	#155	#162
<b>Specifications apply to maximum power setting</b>					
Type	CW DFB laser with built-in isolator				
Center wavelength <sup>1,2</sup>	1310 nm $\pm 5$ nm	1490 nm $\pm 3$ nm	1510 nm $\pm 3$ nm	1550 nm $\pm 3$ nm	1625 nm $\pm 3$ nm
Tuning range	Typ. > $\pm 500$ pm				
- Display resolution	10 pm				
- Repeatability <sup>4</sup>	$\pm 5$ pm (typ. $\pm 2$ pm)				
- Stability (15 min.) <sup>3,4</sup>	$\pm 5$ pm (typ. $\pm 2$ pm)				
- Stability (24 h) <sup>3,4</sup>	Typ. $\pm 5$ pm				
Fiber type	Panda PMF 9 / 125 mm				
Output connector <sup>6</sup>	Compatible to angled contact APC, ASC, DIN47256/4108				
Power	Typ. > +13 dBm (20 mW)				
- Max. output <sup>5</sup>	Typ. $\pm 0.003$ dB				
- CW stability (15 min) <sup>4</sup>	Typ. $\pm 0.01$ dB				
- CW stability (24 h) <sup>3,4</sup>	Typ. 50 dB				
Side mode suppression ratio (SMSR) <sup>5</sup>	Typ. > 20 dB				
Polarization extinction ratio (PER)	75 mm x 32 mm x 335 mm (2.8" x 1.3" x 13.2")				
Dimensions (H x W x D)	0.5 kg				
Weight	2 year				
Recalibration period	15 to 35 °C				
Operating temperature	60 min				
Warm-up time <sup>3</sup>					

- Center wavelength is shown on display as default.
- Via GPIB tuning resolution < 10 pm.
- If previously stored at the same temperature 20 min.
- Controlled environment DT =  $\pm 1$  °C.
- At maximum power setting and default wavelength at the end of a 2m SM patchcord.
- Connector interface not included.

## 8165xA Fabry-Perot Laser Modules

[www.keysight.com/find/oct](http://www.keysight.com/find/oct)

- SMF with 1310, 1550 or 1310/1550 nm
- 20 mW output power
- Excellent CW power stability of  $< \pm 0.005$  dB (15 min.)
- Stable test of patchcords, couplers and connectors



The Keysight Fabry-Perot laser sources are available as single or dual wavelength sources, are insensitive to back reflections, and are stabilize for short and long term applications.

### Flexible application fit

Keysight 8165xA Fabry-Perot laser sources are a family of plug-in modules for Keysight's lightwave solution platform and offer ideal power and loss characterization of optical components and fibers with wavelengths at 1310 nm and 1550 nm, mainly used in optical telecommunication including today's fiber to the home (FTTH) and short reach applications such as Fibre Channel and Gigabit Ethernet.

### Ideal solution for IL, RL and PDL tests

Combination of Keysight's Fabry-Perot laser source and wide variety of power meters (or optical heads) provides the basic setup for insertion loss (IL) characterization. Simple front panel operation together with a power meter immediately show results of IL. Keysight's 8161xA return loss module can utilize an external laser source such as a Fabry-Perot laser to set up a return loss (RL) test. Adding the Keysight 8169A or N7785B polarization controller enables testing of the polarization properties of optical components.

High power modules, +13 dBm	Keysight 81655A	Keysight 81656A	Keysight 81657A
Type		Fabry-Perot laser	
Center wavelength <sup>1</sup>	1310 nm $\pm$ 15 nm	1550 nm $\pm$ 15 nm	1310/1550 nm $\pm$ 15 nm
Fiber type		Single-mode 9/125 $\mu$ m	
Spectral bandwidth (rms) <sup>1,2</sup>	$< 5.5$ nm (high power)	$< 7.5$ nm (high power)	$< 5.5$ nm/ $7.5$ nm (high power)
Output power		$> +13$ dBm (20 mW) (high power)	
CW power stability <sup>3,4</sup>		$< \pm 0.005$ dB	
Short term (15 min.)		Typ. $< \pm 0.003$ dB with coherence control active	
Long term (24 h)		typ. $\pm 0.03$ dB	
To back reflection (RL <sup>3</sup> 14 dB)		typ $\pm 0.003$ dB	
Dimensions (H x W x D)		75 mm x 32 mm x 335 mm (2.8" x 1.3" x 13.2")	
Weight		0.5 kg	
Recalibration period		2 years	
Operating temperature		0 °C to 45 °C	
Humidity		Non condensing	
Warm-up time		60 minutes <sup>3</sup>	

1. Central wavelength is shown on display.

2. rms: root mean square.

3. Warm-up time 20 min, if previously stored at the same temperature.

4. Controlled environment ( $T = \pm 1$  °C).



[www.keysight.com/find/mppm](http://www.keysight.com/find/mppm)

- Patented 4-port optical connector interface for FC, SC, LC, MU and bare-fiber
- Storage of up to 1 million power values per channel for high speed measurement data acquisition and transfer
- Short minimum averaging time of 1  $\mu$ s for high time resolution and transient power measurements
- LAN, USB and GPIB programming interfaces
- High dynamic range with high bandwidth for accurate high-speed spectra
- Code compatibility to Keysight's Lightwave Measurement System platform



Keysight N7745A Multiport Power Meter with Quad-Adapter Connector Interfaces N7740ZI, N7740FI, N7740BI, N7740KI (left to right)

### Up to eight power meter channels in a small package

Keysight's new N7744A and N7745A optical power meters with four or eight power-sensor channels provide manufacturing customers with increased throughput and operational efficiency to meet today's challenges in manufacturing.

### Designed for optical multiport applications

Designed for characterizing optical multiport components, these optical power meters offer industry-leading solutions for device connectivity, high-speed measurement data acquisition and fast data transfer for postprocessing. The multiport power meter enables fast measurement solutions for all multiport devices; for example multiplexers, PON splitters, wavelength selective switches (WSS) and ROADMs, as well as compact setups for simultaneous testing of multiple single-port devices. These power meters are easily integrated with a tunable laser using the N7700A software to make fast IL and PDL measurements.

### Continuous data logging

Each channel can log up to 1 M samples and has an additional 1 M buffer. Sampling can be set between 1  $\mu$ s and 10 s. The buffer allows data upload during measurements for uninterrupted transient power measurement and monitoring.

### A reliable four-port optical connection with a new one-click quad-adapter

With this new power meter comes the unprecedented N7740x fiber connectivity concept, which is a quadruple adapter with a snap-on quick-locking mechanism. The device to be tested can be connected to the quad-adapters in a comfortable ergonomic working position, even while the instrument is measuring another device. Then the quad-adapters can quickly be snapped on, to provide repeatable high-precision connections. Use of the quad-adapters simplifies aligning connector keys, especially for rack-mounted instruments and makes it easier to connect ports in the desired order, helping to avoid errors and connector damage. This quad-adapter fits also into Keysight's standard bare fiber connectivity solutions 81000Bx.

## Keysight N7744A, N7745A

Sensor element	InGaAs
Wavelength range	1250 to 1650 nm
Specification wavelength range	1250 to 1625 nm (if not stated differently)
Power range	- 80 to +10 dBm
Maximum safe power	+16 dBm
Data logging capability	1 million measurement points per port
Averaging time	1 $\mu$ s to 10 s
Applicable fiber type	Standard SM and MM $\leq$ 62.5 $\mu$ m core size, NA $\leq$ 0.24
Uncertainty at reference conditions	$\pm$ 2.5%
Total uncertainty	$\pm$ 4.5%
Relative port to port uncertainty	typ. $\pm$ 0.05 dB
Linearity at (23 $\pm$ 5°C) over operating temperature	$\pm$ 0.02 dB $\pm$ 3 pW $\pm$ 0.04 dB $\pm$ 5 pW
Polarization dependent responsivity	< $\pm$ 0.015 dB (1520 to 1580 nm) Typ. < $\pm$ 0.01 dB (1250 to 1580 nm)
Noise peak-to-peak (dark)	< 7 pW (1 s averaging time, 300 s observation time)
Return loss	> 50 dB (1520 to 1580 nm) typ. > 57 dB (1280 to 1580 nm)
Operating temperature	+5 to +40 °C
Operating humidity	15% to 95%, non-condensing
Storage conditions	-40 °C to +70 °C
Warm-up time	20 min.
Dimensions (H x W x D)	372 mm $\times$ 212 mm $\times$ 43 mm
Weight	3 kg (6 lb)

## N7747A and N7748A High Sensitivity Optical Power Meter

[www.keysight.com/find/jet](http://www.keysight.com/find/jet)

**With the N7747A and N7748A**, the highest optical performance is now offered in the N77 platform for compact automated instrumentation. The high optical performance encompasses the highest sensitivity available with  $-110$  dBm and correspondingly low noise and high stability to accurately measure and monitor weak signals and small signal changes. This is supported by high relative power accuracy with low polarization dependence and low spectral ripple. The high sensitivity together with 9 power ranges at 10 dB spacing provides highest dynamic range with excellent linearity.

These instruments combine the proven optical performance of the 81634B sensor modules with the large memory, fast data transfer and small footprint of the N77 series platform. Eight high-sensitivity optical power meters now fit in a single rack unit. Optical connections are made with the interchangeable 81000xl connector interface system so the instrument can be easily adapted to different fiber connector types. Each optical port has 2 buffers of memory, each able to log up to 1 M samples. With the ability to upload one buffer while the other is recording measurements, this permits continuous monitoring over extended times with sensitivity to small transients. Details for programming this logging are given in the application note 5990-3710. The functionality is the same used in the N7744A and N7745A except that the high-sensitivity models use lower bandwidth to match the low-noise performance.

Like the 81634B and the 8162\*B optical power heads, the N7747A and N7748A include an analog output for each optical channel. This provides a 0 to 2 V signal proportional to the optical power, scaled by the selected power range and allows analog monitoring of signals with up to 5 kHz bandwidth.

The instruments have USB, LAN and GPIB interfaces for control with the SCPI command set also used for the 816x, N7744A and N7745A optical power meters. The updated versions of the N77xx Viewer user interface program and the 816x VXI Plug&Play driver can also be used.



	N7747A and N7748A	-110 dBm
Sensor element	InGaAs	
Wavelength range	800 to 1700 nm	
Power range	$-110$ to $+10$ dBm	
Maximum safe input power	$+16$ dBm	
Applicable fiber type	Standard SM and MM, $\leq 100$ $\mu\text{m}$ core size, $\text{NA} \leq 0.3$	
Uncertainty at reference conditions <sup>1</sup>	$\pm 2.5\%$	
Total uncertainty <sup>2,3</sup>	$\pm 4.5\%$	
Polarization dependent responsivity <sup>4</sup>	$< \pm 0.005$ dB	
Spectral ripple (due to interference) <sup>5</sup>	$< \pm 0.005$ dB	
Linearity <sup>3,6</sup>	$< \pm 0.015$ dB (at $23^\circ \pm 5^\circ\text{C}$ ) $< \pm 0.05$ dB (in operating temperature range) $< \pm 0.005$ dB (fixed power range, within 10 dB of range max.)	
Noise (peak to peak, dark) <sup>7</sup>	$< 0.2$ pW (1200 to 1630 nm)	
Drift		
Return loss	$> 55$ dB	
Analog output	0 to 2 V in to open, 600 ohm typ. output impedance, max input voltage $\pm 10$ V	
Frequency response (3 dB cutoff, also for analog output)	5.0 kHz ( $+10$ dBm to $-20$ dBm range) 4.0 kHz ( $-30$ dBm to $-40$ dBm range) 0.3 kHz ( $-40$ dBm to $-70$ dBm range)	
Averaging time	10 $\mu\text{s}$ to 10 s	
Data logging capability	2 buffers/port, each with 1 Mio. measurement point capacity	

1. Reference conditions: Power level 10  $\mu\text{W}$  ( $-20$  dBm), continuous wave, Fiber 50  $\mu\text{m}$  graded-index,  $\text{NA} = 0.2$ , Ambient temperature  $23^\circ\text{C} \pm 5^\circ\text{C}$ , On day of calibration (add  $\pm 0.3\%$  for aging over 1 year, add  $\pm 0.6\%$  over 2 years), Spectral width of source  $< 10$  nm (FWHM), Wavelength setting at power sensor must correspond to source wavelength  $\pm 0.4$  nm.

2. Operating conditions: Fiber  $\leq 50$   $\mu\text{m}$ ,  $\text{NA} \leq 0.2$ , connectors with 2.5 mm ferrule with flat face (fiber tip offset not more than 0.3 mm from 2.5 mm cross-section) with straight or angled polish, within one year after calibration, add 0.3% for second year, operating temperature range as specified humidity: none condensing.

3. Excluding noise and drift.

4. All states of polarization at constant wavelength ( $1550 \pm 30$  nm) and constant power, straight connector,  $T = 23^\circ\text{C} \pm 5^\circ\text{C}$ . For angled connector ( $8^\circ$ ) add  $\pm 0.01$  dB typ.

5. Test conditions: wavelength  $1550 \pm 30$  nm, fixed state of polarization, constant power, temperature  $23^\circ\text{C} \pm 5^\circ\text{C}$ , linewidth of source  $\geq 100$  MHz, angled connector  $8^\circ$ .

6. CW,  $-90$  to  $+10$  dBm, 1000 to 1630 nm.

7. Averaging time 1 s,  $T = 23^\circ\text{C} \pm 5^\circ\text{C}$ ,  $\Delta T \pm 1^\circ\text{C}$ , observation time 300 s.

[www.keysight.com/find/oct](http://www.keysight.com/find/oct)

- Complete wavelength range, 450 to 1800 nm
- Low uncertainty of  $\leq \pm 0.8\%$  at reference conditions
- Low PDL of  $\leq \pm 0.005$  dB, for polarization sensitive tests
- High single-sweep dynamic range of 55 dB
- High power measurements of up to +40 dBm
- Support of high channel count testing with dual power sensor
- Support of bare-fiber and open-beam applications with a 5 mm detector
- Synchronous measurements with a laser source or external modulation



### Wide variety of optical power sensors and optical heads

The superiority of Keysight's stimulus-response test solutions guarantee performance. Keysight has been an industry leader in optical instrumentation since the early 1980s - excellence in laser sources, reliable power sensor modules and large detector optical heads.

The power measurement instruments are available in two formats: self-contained power sensor modules for front-panel optical fiber connection and external power measurement heads for flexible connection positioning, which are connected to the mainframe using the 81618A or 81619A (dual) interface modules. The external beams with a large 5 mm detector are also useful in many free-space optical configurations.

The flexible connector interface system allows the same instrument to be used with many different types of optical connector.



81628B InGaAs head with integrating sphere

### Passive component test

For multi-channel devices, such as, CWDM and AWG, for R&D or the manufacturing environment, accurate measurements at a minimum cost are in demand. The modular design provides the user with the flexibility to add power meters or mainframes for high channel count or high dynamic range applications. Testing of free space optics, such as, thin film filter (TFF) and waveguide alignment, are easily supported with the optical head. Its 5 mm detector and long, moveable reach provides the user with easy handling.

### Active component test

High power amplifiers and sources are developed today in order to transmit signals over longer distances and to support a high loss environment for complex systems. High power measurements of +40 dBm, can be accomplished without an attenuator, which could add to the measurement uncertainty.

### Optical component test in the visible wavelength range

For measuring visible and near-infrared light, like used in POS (polymer optical fiber) networks, visible LED's or infrared remote control sources, the new 81623B Option E01 external power head is an ideal solution. It covers the wavelength range from 450 to 1020 nm.

### Research and calibration

Low measurement uncertainty of  $< \pm 2.5\%$  and low PDL of  $< \pm 0.005$  dB are a couple of the key features found in the Keysight power sensors. All of Keysight's power meter products are NIST and PTB traceable to guarantee precise optical power measurements. All metrology labs are ISO 17025 certified to meet general requirements for the competence of testing and calibration laboratories.

The instruments can log up to 20 k points with sampling times down to 100  $\mu$ s, or even 100 k points at 25  $\mu$ s with the 81636B. These samples can be triggered by the tunable laser for swept-wavelength spectral measurements. Built-in routines are also included for measuring maximum and minimum power, stability over extended time, and offset from an initial measurement value. Results can be displayed in mW, dBm, or dB change.

### Selection criteria for optical power meters (see also page 38)

#### Optical power sensors

- 81635A: Dual-channel sensor, lowest price
- 81634B: Most accurate sensor, highest sensitivity
- 81636B: Fast power sensor, 100 k points, 25  $\mu$ s averaging, higher dynamic range during logging
- 81630B: Highest power sensor

#### Optical power heads

- 81620B Silicon head, 450-1020 nm
- 81623B: Ge head, general purpose, also specified for 850 nm
- 81624B: InGaAs head, highest accuracy
- 81626B: InGaAs head, high power with high relative accuracy
- 81628B: InGaAs head with integrating sphere, highest power and an accuracy at high power

	Keysight 81635A	Keysight 81634B	Keysight 81630B
Wavelength range	800 to 1650 nm	800 to 1700 nm	970 to 1650 nm
Power range	-80 to +10 dBm	-110 to +10 dBm	-70 to +28 dBm
Applicable fiber type	Standard SM and MM up to 62.5 $\mu$ m core size, NA $\leq$ 0.24	Standard SM and MM up to 100 $\mu$ m core size, NA $\leq$ 0.3	Standard SM and MM up to 100 $\mu$ m core size, NA $\leq$ 0.3
Uncertainty (accuracy) at reference conditions	Typ. $< \pm 3\%$ (1200 to 1630 nm) $\pm 3.5\%$ (800 to 1200 nm)	$\pm 2.5\%$ (1000 to 1630 nm)	$\pm 3.0\%$ for 1255 to 1630 nm at 980 nm $\pm 3.5\%$ (add $\pm 0.5\%$ per nm if 980 nm is not the center wavelength) at 1060 nm $\pm 4.0\%$ (add $\pm 0.6\%$ per nm if 1060 nm is not the center wavelength)
Total uncertainty	Typ. $\pm 5.5\% \pm 200$ pW (800 to 1200 nm) $\pm 5\% \pm 20$ pW (1200 to 1630 nm)	$\pm 4.5\% \pm 0.5$ pW (1000 to 1630 nm)	$\pm 5\% \pm 1.2$ nW (1255 to 1630 nm) at 980 nm $\pm 5.5\% \pm 1.2$ nW (add $\pm 0.5\%$ per nm if 980 nm is not the center wavelength) at 1060 nm $\pm 6.0\% \pm 1.2$ nW (add $\pm 0.6\%$ per nm if 1060 nm is not the center wavelength)
Relative uncertainty – due to polarization – spectral ripple (due to interference)	Typ. $< \pm 0.015$ dB Typ. $< \pm 0.015$ dB	$< \pm 0.005$ dB $< \pm 0.005$ dB	$< \pm 0.01$ dB $< \pm 0.005$ dB
Linearity (power) – at 23°C $\pm 5^\circ$ C – at operating temp. range	CW -60 to +10 dBm Typ. $< \pm 0.02$ dB (800 to 1200 nm) $< \pm 0.02$ dB (1200 to 1630 nm) Typ. $< \pm 0.06$ dB (800 to 1200 nm) $< \pm 0.06$ dB (1200 to 1630 nm)	CW -90 to +10 dBm $< \pm 0.015$ dB (1000 to 1630 nm) $< \pm 0.05$ dB (1000 to 1630 nm)	CW -50 to +28 dBm (970 to 1630 nm) $\leq \pm 0.05$ dB $\leq \pm 0.15$ dB
Return loss	$> 40$ dB	$> 55$ dB	$> 55$ dB
Noise (peak to peak)	Typ. $< 200$ pW (800 to 1200 nm) $< 20$ pW (1200 to 1630 nm)	$< 0.2$ pW (1200 to 1630 nm)	$< 1.2$ nW (1255 to 1630 nm)
Averaging time (minimal)	100 $\mu$ s	100 $\mu$ s	100 $\mu$ s
Analog output	None	Included	Included
Maximum safe input power	$> +16$ dBm	+16 dBm	28.5 dBm
Dimensions (H x W x D)	75 mm x 32 mm x 335 mm (2.8" x 1.3" x 13.2")	75 mm x 32 mm x 335 mm (2.8" x 1.3" x 13.2")	75 mm x 32 mm x 335 mm (2.8" x 1.3" x 13.2")
Weight	0.5 kg	0.5 kg	0.6 kg
Recommended recalibration period	2 years	2 years	2 years
Operating temperature	+10 $^\circ$ C to +40 $^\circ$ C	0 $^\circ$ C to +45 $^\circ$ C	0 $^\circ$ C to +35 $^\circ$ C
Humidity	Non-condensing	Non-condensing	Non-condensing
Warm-up time	20 min	20 min	20 min

Keysight 81636B	
Sensor element	InGaAs
Wavelength range	1250 to 1640 nm
Power range	-80 to +10 dBm
Applicable fiber type	Standard SM and MM up to 62.5 $\mu$ m core size, NA $\leq$ 0.24
Uncertainty (accuracy) at reference conditions	$\pm 3\%$ (1260 to 1630 nm)
Total uncertainty	$\pm 5\% \pm 20$ pW (1260 to 1630 nm)
Relative uncertainty – Due to polarization – Spectral ripple (due to interference)	Typ. $\pm 0.015$ dB Typ. $\pm 0.015$ dB
Linearity (power) – At 23°C $\pm 5^\circ$ C – At operating temperature range	CW -60 to +10 dBm, (1260 to 1630 nm) $< \pm 0.02$ dB $< \pm 0.06$ dB

Keysight 81636B continued	
Return loss	> 40 dB
Noise (peak to peak)	< 20 pW (1260 to 1630 nm)
Averaging time (minimal)	25 $\mu$ s
Dynamic range at manual range mode	
at +10 dBm-range	Typ. > 55 dB
at 0 dBm-range	Typ. > 55 dB
at -10 dBm-range	Typ. > 52 dB
at -20 dBm-range	Typ. > 45 dB
Noise at manual range mode (peak to peak)	CW -60 to +10 dBm, 1260 to 1630 nm
at +10 dBm-range	< 50 nW
at 0 dBm-range	< 5 nW
at -10 dBm-range	< 1 nW
at -20 dBm-range	< 500 pW
Analog output	Included
Dimensions (H x W x D)	75 mm x 32 mm x 335 mm (2.8" x 1.3" x 13.2")
Weight	0.5 kg
Recommended recalibration period	2 years
Operating temperature	+10 °C to +40 °C
Humidity	Non-condensing
Warm-up time	20 min

	Keysight 81623B	Keysight 81623B Cal Opt C85	Keysight 81623B Cal Opt C01	Keysight 81620B (Si Detector)
Applicable fiber type standard open beam		SM and MM max 100 $\mu$ m core size, NA 0.3; Parallel beam max $\varnothing$ 4 mm		
Sensor element		Ge, $\varnothing$ 5 mm		
Wavelength range		750 to 1800 nm		
Power range		-80 to +10 dBm		
Uncertainty at reference conditions	$\pm$ 2.2% (1000 to 1650 nm) $\pm$ 3.0% typ (800 to 1000 nm)	$\pm$ 2.2% (1000 to 1650 nm) $\pm$ 2.5% (800 to 1000 nm)	$\pm$ 1.7% (1000 to 1650 nm) $\pm$ 3.0% (800 to 1000nm)	$\pm$ 2.2% (600 to 1020 nm) <sup>[1]</sup>
Total uncertainty	$\pm$ 3.5% $\pm$ 100 pW (1000 to 1650 nm) $\pm$ 4.0% typ. $\pm$ 250 pW (800 to 1000 nm)	$\pm$ 3.5% $\pm$ 100 pW (1000 to 1650 nm) $\pm$ 3.7% $\pm$ 250 pW (800 to 1000 nm)	$\pm$ 3.0% $\pm$ 100 pW (1000 to 1650 nm) $\pm$ 4.0% typ. $\pm$ 250 pW (800 to 1000 nm)	$\pm$ 4% $\pm$ 0.5 pW (600 to 1020 nm) <sup>[2]</sup>
Relative uncertainty				
- Due to polarization		< $\pm$ 0.01 dB (typ. < $\pm$ 0.005 dB)		
- Spectral ripple (due to interference)		< $\pm$ 0.006 dB (typ. < $\pm$ 0.003 dB)		
Linearity (power)		(CW -60 to +10 dBm)		
- At 23°C $\pm$ 5°C		< $\pm$ 0.025 dB		
- At operating temp. range		< $\pm$ 0.05 dB		
Return loss		> 50 dB, typ. > 55 dB		
Noise (peak to peak)		< 100 pW (1200 to 1630 nm) < 400 pW (800 to 1200 nm)		
Averaging time (minimal)		100 $\mu$ s		
Analog output		Included		
Maximum safe input power		+16 dBm		
Dimensions (H x W x D)		57 mm x 66 mm x 156 mm		
Weight		0.5 kg		
Recommended recalibration period		2 years		
Operating temperature		0 to 40 °C		
Humidity		Non-condensing		
Warm-up time		40 min		

1. Reference conditions:

- Power level 10 W (-20 dBm), continuous wave (CW)
- Parallel beam, 3 mm spot diameter on the center of the detector
- Ambient temperature 23 °C  $\pm$  5 °C
- On day of calibration (add  $\pm$ 0.3% for aging over one year, add  $\pm$ 0.6% over two years)
- Spectral width of source < 10 nm (FWHM)
- Wavelength setting at power sensor must correspond to source wavelength  $\pm$ 0.4 nm

2. Operating conditions:

- Parallel beam, 3 mm spot diameter on the center of the detector or connectorized fiber with NA  $\leq$  0.2 (straight connector)
- Averaging time 1s
- For NA > 0.2: add 1%
- Within one year after calibration, add 0.3% for second year
- Spectral width of source < 10 nm (FWHM)
- Wavelength setting at power sensor must correspond to source wavelength  $\pm$ 0.4 nm

	Keysight 81624B	Keysight 81624B Cal Opt. C01	Keysight 81626B	Keysight 81626B Cal Opt. C01
Sensor element	InGaAs, $\varnothing$ 5 mm		InGaAs, $\varnothing$ 5 mm	
Wavelength range	800 to 1700 nm		850 to 1650 nm	
Power range	-90 to +10 dBm		-70 to +27 dBm (1250 to 1650 nm) -70 to +23 dBm (850 to 1650 nm)	
Applicable fiber type Open beam	Standard SM and MM max 100 $\mu$ m core size, NA $\leq$ 0.3 Parallel beam max $\varnothing$ 4 mm		Standard SM and MM max 100 $\mu$ m core size, NA $\leq$ 0.3 Parallel beam max $\varnothing$ 4 mm	
Uncertainty at reference conditions	$\pm$ 2.2 % (1000 to 1630 nm)	$\pm$ 1.5 % (970 to 1630 nm)	$\pm$ 3.0 % (950 to 1630 nm)	$\pm$ 2.5 % (950 to 1630 nm)
Total uncertainty	$\pm$ 3.5% $\pm$ 5 pW (1000 to 1630 nm)	$\pm$ 2.8% $\pm$ 5 pW (970 to 1630 nm)	$\pm$ 5.0% $\pm$ 500 pW (950 to 1630 nm)	$\pm$ 4.5% $\pm$ 500 pW, (1250 to 1630 nm, max 27 dBm)
Relative uncertainty - Due to polarization - Spectral ripple (due to interference)	$\leq$ $\pm$ 0.005 dB (typ. $\pm$ 0.002 dB) $\leq$ $\pm$ 0.005 dB (typ. $\leq$ $\pm$ 0.002 dB)		$\leq$ $\pm$ 0.005 dB (typ. $\pm$ 0.002 dB) $\leq$ $\pm$ 0.005 dB (typ. $<$ $\pm$ 0.002 dB)	
Linearity (power) - At 23 $\pm$ 5 $^{\circ}$ C - At operat. temp. range	CW -70 to +10 dBm, 1000 to 1630 nm $<$ $\pm$ 0.02 dB $<$ $\pm$ 0.05 dB		CW -50 to +27 dBm, 950 to 1630 nm $<$ $\pm$ 0.04 dB $<$ $\pm$ 0.15 dB	
Return loss typ.	60 dB		$>$ 45 dB	$>$ 47 dB
Noise (peak to peak)	$<$ 5 pW		$<$ 500 pW	
Averaging time (min.)	100 $\mu$ s		100 $\mu$ s	
Analog output	Included		Included	
Maximum safe input power	+16 dBm		+23.5 dBm (850 to 1250 nm) / +27.5 dBm (1250 to 1650 nm)	
Dimensions (H x W x D)	57 mm x 66 mm x 156 mm		57 mm x 66 mm x 156 mm	
Weight	0.5 kg		0.5 kg	
Recommended recalibration period	2 years		2 years	
Operating temperature	0 to 40 $^{\circ}$ C		0 $^{\circ}$ C to +35 $^{\circ}$ C	
Humidity	Non-condensing		Non-condensing	
Warm-up time	40 min		40 min	

#### Keysight 81628B with Integrating Sphere

Sensor element	InGaAs		
Wavelength range	800 to 1700 nm		
Power range	-60 to +40 dBm (800 to 1700 nm), for operation higher than 34 dBm <sup>1</sup>		
Damage power	40.5 dBm		
Applicable fiber type / open beam	Single mode NA $\leq$ 0.2, Multimode NA $\leq$ 0.4 / $\varnothing$ $\leq$ 3 mm center of sphere		
Uncertainty at reference conditions	$\pm$ 3.0 % (970 to 1630 nm)		
Total uncertainty	(970 to 1630 nm) $\leq$ 10 dBm $>$ 10 to $\leq$ 20 dBm $>$ 20 to $\leq$ 38 dBm		
	$\pm$ 4.0% $\pm$ 5 nW $\pm$ 4.5% $\pm$ 5%		
Relative uncertainty - Due to polarization - Due to speckle noise at source linewidth:	Typ. $\leq$ 0.006 dB		
0.1 to 100 pm $>$ 100 pm	Typ. $<$ $\pm$ 0.02 dB Typ. $<$ $\pm$ 0.002 dB		
Linearity (power) $\leq$ 10 dBm $>$ 10 to $\leq$ 20 dBm $>$ 37 to $\leq$ 38 dBm	(CW -40 to +38 dBm), (970 to 1630 nm) $\leq$ $\pm$ 0.03 dB $\leq$ $\pm$ 0.09 dB $\leq$ $\pm$ 0.10 dB		
	At 23 $^{\circ}$ C $\pm$ 5 $^{\circ}$ C, for operating temperature range add $\pm$ 0.03 dB		
Return loss	Typ. $>$ 75 dB	Noise (peak to peak)	$<$ 5 nW
Averaging time (minimal)	100 $\mu$ s	Analog output	Included
Dimensions (H x W x D)	55 mm x 80 mm x 250 mm	Operating temperature	0 to +40 $^{\circ}$ C
Weight	0.9 kg (without heat sink)	Humidity	Non-condensing
Recommended recalibration period	2 years	Warm-up time	40 min

1. For optical power higher than 34 dBm the attached heat sink MUST be used! For continuous optical power or average optical power higher than 38 dBm the connector adapters will get warmer than permitted according to the safety standard IEC 61010-1. The 81628B Optical Head can handle optical power up to 40 dBm, however, operation above 38 dBm is at the operator's own risk. Keysight Technologies Deutschland GmbH will not be liable for any damage caused by an operation above 38 dBm.



[www.keysight.com/find/oct](http://www.keysight.com/find/oct)

- Single module for return loss (RL) test
- High dynamic range of 75 dB
- Built-in Fabry-Perot laser source for 1310 and 1550 nm
- Use any external laser source, including tunable laser for swept RL applications
- Three easy calibration steps for enhanced accuracy



### Meeting manufacturing needs

The need for IL and RL for optical component tests is fulfilled with the RL module when used with an optical power meter - preferably an optical head due to its flexibility. On-board application software supports step-by-step operation with instructions.

### Swept RL measurement with tunable laser source

Today's passive component devices are not only characterized at a single wavelength, but over a wide wavelength range using a tunable laser source. The swept wavelength measurement concept is applicable for RL measurements using a Keysight tunable laser source (TLS) in synchronous operation of the two modules. The N7700A-100 PDL software supports use of the return loss modules as well.

### Plug&Play for RL measurement

Portability and cost effective; a single mainframe, single module and single connection to the device under test are all you need to make a return loss (RL) measurement. Keysight's RL test solution solves the complex operation of calibration and is able to exclude measurement uncertainties due to coupler/filter usage in your design. In addition, a built-in FP laser at 1310 and 1550 nm enables basic component tests.

	81610A		81613A	
Source	External input only		Fabry-Perot laser (internal)	
Output power	-		Typ. -4 dBm	
Center wavelength	-		1310 nm/1550 nm ± 20 nm typ.	
Sensor element	InGaAs		InGaAs	
Fiber type	Standard single-mode 9 / 125 μm		Standard single-mode 9/125 μm	
External input	Max input power: 10 dBm Min input power: 0 dBm Damage input power: 16 dBm		- - -	
Wavelength range for external input	1250 to 1640 nm		-	
Dynamic range	70 dB		75 dB	
Relative uncertainty of return loss (RL)	With broadband source	With Keysight FP sources	User calibration	Plug&play
RL ≤ 55 dB	< ± 0.25 dB	Typ. < ± 0.5 dB	< ± 0.5 dB (typ. < ± 0.3 dB)	typ. < ± 0.6 dB
RL ≤ 60 dB	< ± 0.3 dB	Typ. < ± 1.0 dB	< ± 0.6 dB (typ. < ± 0.4 dB)	typ. < ± 1.5 dB
RL ≤ 65 dB	< ± 0.65 dB	Typ. < ± 2.0 dB	< ± 0.8 dB (typ. < ± 0.5 dB)	-
RL ≤ 70 dB	< ± 1.7 dB	-	< ± 1.9 dB (typ. < ± 0.8 dB)	-
RL ≤ 75 dB	-	-	typ. < ± 2.0 dB	-
Total uncertainty add	± 0.2 dB add	typ. ± 0.2 dB	Add ± 0.2 dB	Add typ. ± 0.2 dB
Dimensions (H x W x D)	75 mm x 32 mm x 335 mm (2.8" x 1.3" x 13.2")		75 mm x 32 mm x 335 mm (2.8" x 1.3" x 13.2")	
Weight	0.6 kg		0.6 kg	
Recommended recalibration period	2 years		2 years	
Operating temperature	10 to 40 °C		10 to 40 °C	
Humidity	Non-condensing		Non-condensing	
Warm-up time	20 minutes		20 minutes	

# N7781B Polarization Analyzer

[www.keysight.com/find/pol](http://www.keysight.com/find/pol)



The Keysight N7781B is a compact high-speed polarization analyzer which provides comprehensive capabilities for analyzing polarization properties of optical signals. This includes representation of the State of Polarization (SOP) on the Poincaré Sphere (Stokes Parameter). The on-board algorithms together with the on-board calibration data ensure highly accurate operation across a broad wavelength range.

Due to its real time measurement capability (1 MSamples/s) the instrument is well suited for analyzing disturbed and fluctuating signals as well as for control applications requiring real time feedback of polarization information.

Analogue data output ports are provided, for example for support of control loops in automated manufacturing test systems.

Powerful User Interface and remote programming capabilities are provided by the Polarization Navigator software package of the N7700A Photonic Application Suite.

## Key features:

- Measurement of Stokes Parameter (SOP)
- Measurement of degree of polarization (DOP)
- High-speed operation (> 1 MSamples/s)
- Analog output port for DOP/SOP data

## Monitoring/Measurement application of

- State of Polarization (SOP), Stokes Parameter
- Degree of Polarization (DOP)
- High-Speed Analysis of SOP/DOP of Recirculating Signal

## Instrument setup: Polarization analyzer setup

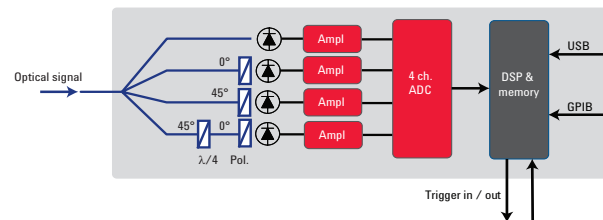

The instrument setup of the Keysight N7781B polarization analyzer is shown in the figure above. It consists of a unique polarimeter optics and a high-speed sampling subsystem. The measurement principle is based on splitting the light into four sub beams which are filtered through different polarizers. The resulting four power levels are evaluated using on-board calibration data to obtain an accurate SOP- and DOP-measurement.

## N7781B Polarization Analyzer <sup>1</sup>

### Wavelength

Specification wavelength range	1270 to 1375 nm (Opt 300, O-band) 1270 to 1375 nm, 1460 to 1620 nm (Opt 400, O/C/L-band) 1460 to 1620 nm (Opt 500, C/L-band)
--------------------------------	--

Operating wavelength range <sup>2</sup>	1260 to 1640 nm
---	-----------------

### Polarization analysis

SOP uncertainty <sup>3,4</sup> (typ.), DOP uncertainty <sup>3</sup>	1.5° / ± 2.0%
---	---------------

DOP uncertainty after user calibration <sup>3,5</sup> (typ.)	± 0.5%
--	--------

Maximum sampling rate	Up to 1 MHz
-----------------------	-------------

### Optical power measurement

Relative power uncertainty <sup>3</sup>	C/L-band: ± 0.03 dB (± 0.02 dB typ.), O-band: ± 0.07 dB (± 0.04 dB typ.)
---	---

Input power range	-50 to +7 dBm
-------------------	---------------

Maximum safe optical input power	+12 dBm
----------------------------------	---------

1. Ambient temperature change max. ± 0.5°C since normalization. Specification valid on day of calibration.
2. SOP/DOP measurements are possible outside the specification wavelength range if a manual user calibration is performed.
3. Input power > -30 dBm
4. DOP > 95%
5. User calibration requires a source with DOP = 100%. User calibration is valid for a fixed wavelength.

[www.keysight.com/find/pol](http://www.keysight.com/find/pol)



Keysight's N7782B series of PER analyzers has been designed for high speed and highly accurate testing of the polarization extinction ratio (PER) in PM fibers. The polarimetric measurement principle guarantees reliable measurements of PER values of up to 50 dB.

The real time measurement capability in combination with automation interfaces makes this unit ideally suited for integration in manufacturing systems, for example pig-tailing stations for laser diodes and planar waveguide components. Analog interfaces are provided for integration of the system in control loop applications.

### Key benefits

- Accurate PER-measurement up to 50 dB
- Real-time display of PER
- Easy-to-use: Reliable results independent of operator skill set
- Swept-wavelength and heating/stretching method available
- Measurement of the PER versus wavelength
- Fast/slow axis detection
- Instruments available for 1260 up to 1640 nm
- Internal fixed wavelength sources at 850 nm/1310 nm/1550 nm available

### Applications

- **Laser diode PMF pig-tailing** Alignment of the PM fiber during the pig tailing process is supported by real-time display of the PER and the optical power
- **PMF splicing** In order to support the alignment during the splicing process of PM fibers the Keysight N7782B provides real time display of the optical power and of the angular misalignment of the two fibers
- **PM component characterization** measurement of the PER on PM components like fiber polarizers, PMF couplers, PMF splitters, etc.
- **Characterization of PMF cross-coupling** polarization crosstalk in a PM fiber is measured and displayed as PER
- **PM splice characterization** The angular misalignment of a PM splice can be measured in a non-destructive way. Even multiple splices in a chain can be characterized independently.

### Keysight N7782B and N7783B application examples

#### The wavelength scanning method

Using Keysight's tunable laser source 81600B series in combination with the Keysight N7782B PER analyzer allows measuring the PER as a function of wavelength.

#### The heating/stretching method

The heating/stretching method provides accurate measurements of the PER at a single wavelength. This method supports in particular well the measurement using narrow-band laser sources. An optional internal laser source allows stand-alone operation of the system.

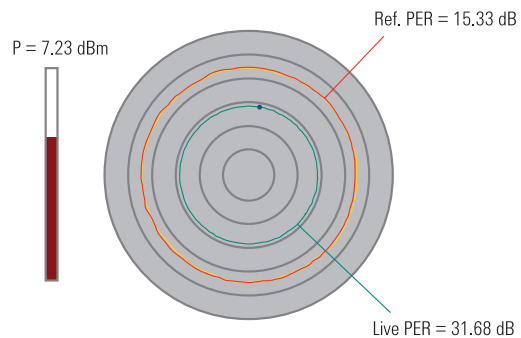

Keysight's thermal cycling unit N7783B is fully controlled by the Keysight N7782B PER analyzer and allows accurate and repeatable cycling of the temperature of the fiber under test. The PER measurement system consisting of the Keysight N7782B and the Keysight N7783B shows excellent accuracy and repeatability. Ease of use and automation interfaces, such as analog output ports for active alignment, make it particularly useful for production environments.

#### N7783B thermal cycling unit

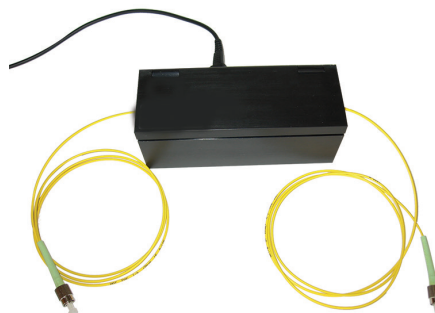

For characterizing an optical connection between two polarization maintaining fibers (PMFs), such as an optical splice, two thermal cycling units (Keysight N7783B) can be used. This eliminates the influence of input polarization or subsequent fibers at the output and isolates the angular misalignment of the connection located between the two thermal cycling units.

**Specifications <sup>1</sup> N7782B PER Analyzer****Wavelength**

Specification wavelength range	1270 to 1375 nm (Opt 300, O-band) 1270 to 1375 nm, 1460 to 1620 nm (Opt 400, O/C/L-band) 1460 to 1620 nm (Opt 500, C/L-band)
Operating wavelength range <sup>2</sup>	1260 to 1640 nm (Opt 300/400/500)

**PER analysis**

PER range <sup>3,4</sup>	0 to 50 dB	
PER uncertainty, single-TCU method (typ.) <sup>3,4</sup>	PER = 0 to 30 dB	0.30 dB
	PER = 30 to 50 dB	0.60 dB

**Splice angle analysis**

Splice angle uncertainty, dual-TCU method (typ.) <sup>3,4</sup>	$\pm (0.1^\circ + 4\% \times \text{angle})$
---	---

**Optical power**

Input power range	-50 to +7 dBm (Opt 300/400/500)
Relative power uncertainty <sup>3</sup>	C/L-band: $\pm 30$ mdB ( $\pm 20$ mdB, typ.) O-band: $\pm 70$ mdB ( $\pm 40$ mdB, typ.)

**Internal laser source**

Wavelength	Opt. 401 (O-band): 1290 to 1360 nm, 1310 nm typ. Opt. 501, 401 (C-band): 1510 to 1580 nm, 1550 nm typ.
Output power <sup>5</sup> (typ.)	Opt. 401 (O-band): -12 dBm Opt. 501, 401 (C-band): -10 dBm

1. Ambient temperature change max.  $\pm 0.5^\circ\text{C}$  since normalization. Specification valid on day of calibration.
2. PER measurements are possible outside the specification wavelength range if the user performs a manual calibration. Note that a fully polarized light source is needed for calibration.
3. Input power  $> -30$  dBm
4. Narrow-band light source with DOP  $> 95\%$  needed.
5. At room temperature.

**N7783B Thermal Cycling Unit Characteristics**

Fiber jacket diameter	Up to 3 mm
Ambient temperature range	20 to 30 °C
Minimum peak-to-peak temperature tuning range	50 K
Power	100 to 240 VAC, $< 36$ W
Dimensions (H x W x D)	64 mm x 160 mm x 61 mm

[www.keysight.com/find/pol](http://www.keysight.com/find/pol)



N7784B



N7785B



N7786B

These 3 instruments are all based on high-speed solid state optics to rapidly switch the polarization of an incoming signal. They are used with polarized input signals from lasers and can adjust, scan or align the output state of polarization. The instruments are controlled from an external PC and convenient graphical user interface control is provided with the included Polarization Navigator software, distributed with the N7700A Photonic Application Suite. Automated control is provided by the GPIB and USB interfaces.

### N7785B Synchronous scrambler

The N7785B Synchronous scrambler provides fast SOP switching in response to internal or external triggering. This supports optical network simulations that often require switching of the signal SOP in a random way within a few microseconds, such as in recirculating loop tests. The SOP is switched rapidly, and then held for a predefined time until it again switches to a new SOP. The output SOP is controlled but not determined by the N7785B and will be changed if the input SOP changes. The output SOP can be adjusted to a desired external condition, such as

maximizing the signal through a polarizer. Application routines in the Polarization Navigator software can be used for random scrambling and continuous scrambling (where the state of polarization moves smoothly about the Poincaré sphere, similar to a flipper-style scrambler) over a wide range of speeds as for fast SOP-change tolerance testing of coherent receivers.

### N7784B Polarization controller

The N7784B Polarization controller provides alignment and fast stabilization of SOP into polarization maintaining fiber (PMF) or with respect to an external condition by adding an analog feedback and polarizer path to the basic N7785B configuration.

For alignment into PMF, the input signal is first routed through the fast switching controller with single-mode fiber (SMF) and is available at an intermediate front panel output. An external jumper fiber is used to route the signal into the polarizer path consisting of a polarizing beam splitter with one output monitored by a photodetector. The other output is coupled to the front panel output with PMF. The signal from the photodetector is used to actively align and stabilize the input signal into the PMF output that could then be connected to a modulator or other polarization dependent device. Similarly, the signal can be used directly from the intermediate output and a user-configured setup can provide the feedback for optimizing the desired SOP from the instrument.

### N7786B Polarization synthesizer

The N7786B Polarization synthesizer includes internal SOP monitoring and feedback via a tap coupler to determinately set and hold any chosen states or sequences of polarization. This allows generation of sequences with chosen relative SOP orientation. This is often used for component analysis based on Mueller Matrix or Jones Matrix analysis. The uniquely fast switching supports the new single-sweep spectral PDL measurements with the N7700A software, which eliminates sensitivity to environmental stability and minimizes measurement time. Analysis of these results into transmission spectra of the primary device axes (like TE and TM) is also achieved in this way. The real-time monitoring and logging of output SOP permits accurate calculation including the wavelength dependence of the SOP.

The real-time monitoring and feedback also are used in this instrument to provide stabilized SOP, even with fluctuation and drift of the input SOP.

#### The output SOP can be defined in following ways:

- Set-and-forget: When the front panel button is pushed, the current SOP is stored and maintained, even if polarization changes occur at the instrument input
- Defined Stokes: The target output SOP can be defined by the user using the Stokes parameters

The Polarization Navigator also has a convenient button to quickly change from a manually adjusted SOP to the corresponding orthogonal state, as can be used to check extinction ratio.

**Specifications <sup>1</sup> N7784B Polarization Controller****Wavelength**

Operating wavelength range   Wavelength range in stabilizer mode <sup>2</sup>	1260 to 1640 nm   1520 to 1580 nm
---	-----------------------------------

**Polarization control and stabilization**

SOP switching time (open-loop)	< 10 $\mu$ s
--------------------------------	--------------

PER at PMF output (typical)	> 23 dB
-----------------------------	---------

Stabilizer response time <sup>3</sup> (typ.)	2 ms
--	------

**Optical power**

Insertion loss port I $\rightarrow$ port II <sup>4</sup>   Insertion loss port III $\rightarrow$ port IV <sup>5</sup>	< 3.5 dB (< 3.0 dB, typ.)   < 1.8 dB (< 1.4 dB, typ.)
---	---

PDL port I $\rightarrow$ port II (typ.)	< 0.2 dB (C/L-band), < 0.5 dB (O-band)
---	--

Maximum safe input power	Port I: 20 dBm, Port III: 3 dBm
--------------------------	---------------------------------

Input power range in stabilizer mode	Port III: -30 to 0 dBm
--------------------------------------	------------------------

1. Ambient temperature change max.  $\pm 0.5$  °C since normalization. Specification valid on day of calibration;
2. Outside the stabilizer wavelength range, the PER at PMF Output may be degraded;
3. Input power at Port III > -30 dBm, response to an immediate step of 180° on the Poincaré sphere;
4. For SOP scrambling/switching, only ports I/II are used;
5. Valid for optimum input polarization at PBS input (Port III). Add insertion loss of port I/II and III/IV to obtain total insertion loss for SOP stabilizing mode.

**Specifications <sup>1</sup> N7785B Synchronous Scrambler****Wavelength**

Operating wavelength range	1260 to 1640 nm
----------------------------	-----------------

**Polarization control**

SOP switching time	< 10 $\mu$ s
--------------------	--------------

**Optical power**

Insertion loss	< 3.5 dB (< 3.0 dB, typ.)
----------------	---------------------------

PDL (typ.)	< 0.2 dB (C/L-band), < 0.5 dB (O-band)
------------	--

Maximum safe input power	20 dBm
--------------------------	--------

1. Ambient temperature change max.  $\pm 0.5$  °C since normalization. Specification valid on day of calibration

**Specifications <sup>1</sup> N7786B Polarization Synthesizer****Wavelength**

Specification wavelength range	1270 to 1375 nm, 1460 to 1620 nm (Opt 400, O/C/L-band) 1460 to 1620 nm (Opt 500, C/L-band)
--------------------------------	---

Operating wavelength range <sup>2</sup>	1260 to 1640 nm
---	-----------------

**Polarization control and stabilization**

SOP switching time (non deterministic)   SOP cycling time <sup>6</sup>	< 10 $\mu$ s   < 25 $\mu$ s
--	-----------------------------

Remaining SOP error after deterministic SOP setting (typ.) <sup>7</sup>	< 3° / < 6.5° at input SOP movement rate of 1.2 rad/s / 40 rad/s
---	--

**Polarization analysis**

SOP uncertainty <sup>3,4</sup>	1.5°
--------------------------------	------

DOP uncertainty <sup>3</sup>   DOP uncertainty after user <sup>3,5</sup> calibration (typ.)	$\pm 2.0\%$   $\pm 0.5\%$
---	---------------------------

**Optical power measurement**

Relative power uncertainty <sup>3</sup>	C/L-Band: $\pm 0.14$ dB ( $\pm 0.12$ dB typ.), O-band: $\pm 0.16$ dB ( $\pm 0.14$ dB typ.)
---	--

Input power range	-38 to +19 dBm
-------------------	----------------

**Optical power**

Insertion loss	< 4.0 dB (< 3.5 dB, typ.)
----------------	---------------------------

PDL (typ.)	< 0.2 dB (C/L-band), < 0.5 dB (O-band)
------------	--

Maximum safe input power	20 dBm
--------------------------	--------

1. Ambient temperature change max.  $\pm 0.5$  °C since normalization. Specification valid on day of calibration.
2. SOP/DOP measurements are possible outside the specification wavelength range if the user performs a manual calibration.
3. Input power > -20 dBm.
4. DOP > 95%.
5. User calibration requires a source with a 100% DOP.
6. The instrument adaptively finds the polarization controller settings to let the SOP cycle through user-defined polarization states (closed loop operation). After having found these settings, the SOP can cycle through the polarization states in open loop operation.
7. This value is defined to be 5 times the standard deviation of the angular SOP error on the Poincaré sphere. Valid if controller is turned on. Power at instrument input > -10 dBm.



- Precise manual & remote adjustments of polarization state
- Nine Save/Recall registers of SOP
- Continuous auto scanning, tuning the SOP across the entire Poincare sphere



Polarization sensitive devices include EDFAs, single-mode fiber, polarization maintaining fiber, isolators, switches, lasers, couplers, modulators, interferometers, retardation plates and polarizers. Device performance will be affected by polarization-dependent efficiency, loss, gain and polarization mode dispersion. These polarization phenomena enhance or degrade performance depending on the application area, be it communications, sensors, optical computing or material analysis.

### An Important Part of a Measurement System

A polarization controller is an important building block of an optical test system because it enables the creation of all possible states of polarization. The polarized signal stimulates the test device while the measurement system receiver monitors the test device's responses to changing polarization. Sometimes polarization must be adjusted without changing the optical power. At other times, polarization must be precisely synthesized to one state of polarization (SOP) and then adjusted to another SOP according to a predetermined path.

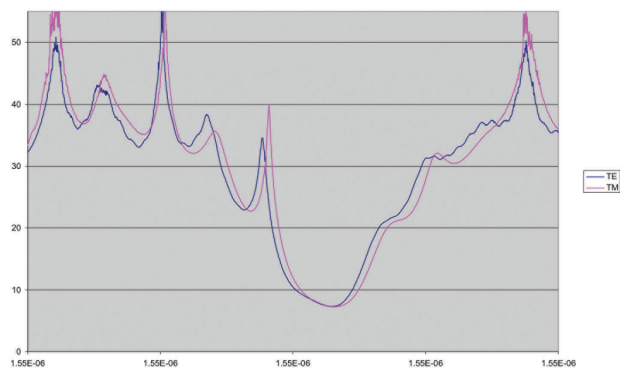

Characterizing the polarization-dependent wavelength shift of a passive optical component

### The Keysight 8169A Polarization Controller

The 8169A Polarization Controller, with single-mode fiber input and output, is used to change light from any polarized or unpolarized light source into any well-defined state of polarization. The design based on bulk-optic zero-order waveplates and a high-performance linear polarizer at the input provides optimum determination and repeatability of polarization states over a wide wavelength range.

The 8169A has long been used together with a tunable laser to make swept-wavelength measurements of the polarization dependence of fiberoptic devices, by setting a set of relatively orthogonal polarization states for Mueller Matrix analysis and making separate sweeps for each state. These measurements are supported by the N4150A Photonic Foundations Library software package. This method is still supported, but the single-sweep method using the N7786B and N7700A PDL software generally provide a faster and more robust solution.

The fundamental basis of this flexible instrument also supports many general applications requiring polarization control and analysis. The high extinction ratio and simple stable optics make this an excellent tool for polarization nulling arrangements, finely adjusting the polarization for minimal transmission through a polarizer or polarizing beam splitter.

### Specifications

Specifications describe the instruments' warranted performance over the 0 °C to +55 °C temperature range after a one-hour warm-up period. Characteristics provide information about non-warranted instrument performance. Specifications are given in normal type. Characteristics are stated in italicized type. Spliced fiber pigtail interfaces are assumed for all cases except where stated otherwise.

Operating Wavelength Range	1400 to 1640 nm
Insertion Loss	< 1.5 dB
Variation over 1 full rotation	< ± 0.03 dB
Variation over complete wavelength range	< ± 0.1 dB
Polarization Extinction Ratio	45 dB (1530 to 1560 nm) > 40 dB (1470 to 1570 nm) > 30 dB (typ.) (1400 to 1640 nm)
Polarization Adjustment Resolution	0.18° (360°/2048 (encoder positions))
Fast axis alignment accuracy at home position	± 0.2°
Angular adjustment accuracy	minimum step size ±0.09° greater than minimum step size <± 0.5°
Settling time (characteristic)	< 200 ms
Memory Save/Recall registers	9
Angular repeatability after Save/Recall	± 0.09°
Number of scan rate settings	2
Maximum rotation rate	360°/sec
Maximum Operating Input Power Limitation	+23 dBm
Operating Port Return Loss (characteristic)	Total reflection – Individual reflections > 60 dB
Power Requirements	48 to 60 Hz 100/120/220/240 Vrms 45 VA max
Weight	9 kg (20 lb)
Dimensions (H x W x D)	10 x 42.6 x 44.5 cm 3.9 x 16.8 x 17.5 in



N7788B optical component analyzer

### General information

Keysight Technologies pushes the limits of component measurements with the N7788B Component Analyzer. Its proprietary technology is comparable with the well-known Jones-Matrix-Eigenanalysis (JME) which is the standard method for measuring Polarization Mode Dispersion (PMD) or differential group delay (DGD) of optical devices. Compared to the JME, Keysight's new single scan technology offers a range of advantages:

A complete set of parameters:

- DGD/ PMD / PDL / 2nd order PMD
- Power / Loss
- TE / TM-Loss
- Principal States of Polarization (PSPs)
- Jones and Mueller Matrices

For measuring these parameters, the N7788B is used together with a Keysight continuous-sweep tunable laser like the 81600B or 81960A, and control is provided with the Polarization Navigator package of the N7700A Photonic Application Suite. The N7788B also provide the full polarization analysis functionality of the N7781B.

### High measurement speed:

- Complete measurement across C/L-band in less than 10 seconds (no need to wait for many averages)
- Robustness against fiber movement/vibration and drift:
- Fixing fibers with sticky tape on the table or even operation on isolated optical table is not required!
- No limitation on optical path length of component
- The internal referencing scheme guarantees reliable and accurate measurements.

### Applications

- Fiber characterization: SMF, PMF, DCF
- Passive component testing: Filters, isolators, circulators
- Dynamic component/module testing: OADM/ROADM
- Active component testing: EDFAs, SOAs, VOAs
- Link test: In-Channel measurements across amplifiers

## Designed for the manufacturing floor

### High throughput:

A complete analysis across the C and the L band is performed in less than 10 seconds!

### Remote control:

Control of the instrument and application software with the COM interface provides powerful and convenient automation.

### Report generation:

Generating PDF reports is supported. The content including layout is configurable by the user.

### Real-time power readout:

High throughput measurement of non-connectorized components is supported by providing a real time power readout which enables fiber coupling of the new device.

## Instrument setup and application examples

N7788B PMD/PDL component analyzer setup

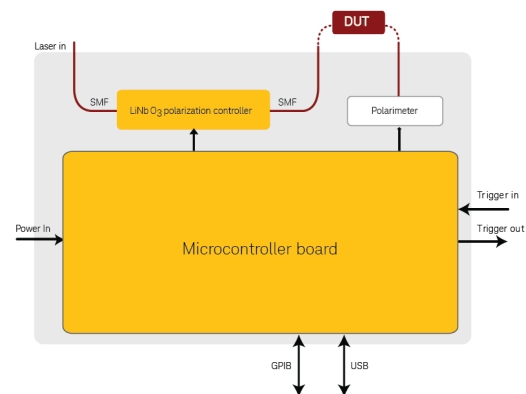

The instrument setup is shown in the figure above. A Lithium-Niobate polarization controller determines the input polarization to the DUT. While the tunable laser source<sup>1</sup> is sweeping over the desired wavelength range, a polarimeter analyzes the output state of polarization while input polarization is being modified. The result will be a highly accurate device characterization with respect to DGD/PDL/Loss etc. Furthermore, the internal optical switch provides continuous self calibration for excellent repeatability.

### Resolving TE/TM insertion loss

The TE/TM-function allows accurate determination of the minimum and maximum loss of the DUT at each wavelength. Due to birefringence, optical filters tend to show different transmission functions depending on the polarization state.

## Long term measurements

The capability of performing quick PMD-measurements makes this measurement system well-suited for collecting long-term PMD data. The PC software allows to continuously collect the spectral PMD data and store it on the hard disc. The data can then be visualized as pseudo-color plot (see figure).

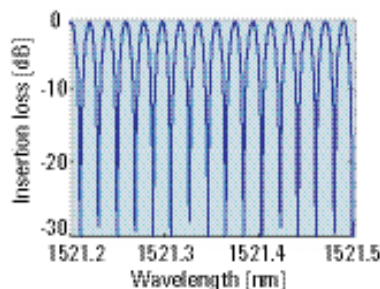
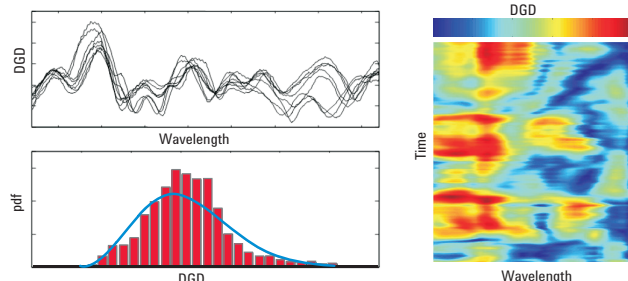

## Excellent spectral resolution

Due to the excellent spectral resolution with the 81600B TLS, the Keysight N7788B is best suited for intra-channel DGD/PDL characterization. The All-Parameter-JME algorithm allows flexible adjustments of the wavelength resolution without the need to repeat the measurement. This simplifies finding the optimum trade-off between PDL/DGD accuracy and wavelength resolution.

### Specifications <sup>1</sup> N7788B Optical Component Analyzer

#### Wavelength

Specification wavelength range	1270 to 1375 nm (Opt 300, O-band) 1270 to 1375 nm, 1460 to 1620 nm (Opt 400, O/C/L-band) 1460 to 1620 nm (Opt 500, C/L-band)
--------------------------------	--

Operating wavelength range <sup>2</sup>	1260 to 1640 nm
---	-----------------

#### Differential delay

DGD uncertainty <sup>3</sup>	Resolution 2.0 nm: $\pm (30 \text{ fs} + 3.0\% \times \text{DGD})$ Resolution 0.1 nm: $\pm (30 \text{ fs} + 3.0\% \times \text{DGD})$
------------------------------	--

DGD measurement range <sup>3</sup>	0 to 1000 ps
------------------------------------	--------------

PMD uncertainty <sup>4</sup>	$\pm (30 \text{ fs} + 2.0\% \times \text{PMD})$
------------------------------	---

PMD repeatability (typ.)	$\pm 3 \text{ fs}$
--------------------------	--------------------

PMD measurement range <sup>4</sup>	0 to 300 ps
------------------------------------	-------------

#### Loss

PDL uncertainty <sup>5</sup>	C/L-band: $\pm (0.05 \text{ dB} + 4\% \times \text{PDL})$
------------------------------	---

O-band: $\pm (0.10 \text{ dB} + 4\% \times \text{PDL})$
---

PDL repeatability (typ.)	$\pm 0.005 \text{ dB}$
--------------------------	------------------------

Insertion loss uncertainty (typ.) <sup>3</sup>	C/L-band: $\pm 0.03 \text{ dB}$
--	---------------------------------

O-band: $\pm 0.07 \text{ dB}$
-------------------------------

Insertion loss dynamic range (typ.) <sup>3</sup>	> 41 dB (for TLS power levels higher than -6 dBm, increase value accordingly)
--	---

#### Polarization analysis

See N7781B specifications

#### Optical power measurement

See N7781B specifications

1. Ambient temperature change max.  $\pm 0.5^\circ\text{C}$  since normalization. Valid for 81600B tunable laser source family. Tunable laser power set to -6 dBm. Sweep over specification wavelength range. Specification does not include instability in test device. Specified loss ranges include loss of test device and any additional switches or connections in the optical path. Specification valid on day of calibration.
2. SOP/DOP measurements are only possible outside the specification wavelength range if the user performs a manual calibration.
3. DUT properties: Insertion Loss < 30 dB, PDL < 1 dB, DGD < 150 ps. Specification is typical for DGD > 150 ps.
4. DUT properties: Insertion Loss < 41 dB, PDL < 3 dB, PMD < 50 ps. Applies for highly mode-coupled devices such as single mode fibers. Specification applies for PMD being the averaged DGD over a wavelength span of 100 nm. Specification is typical for PMD > 50 ps.
5. DUT properties: Insertion Loss < 25 dB, PDL < 6 dB. Note: DUT connectors are considered being part of the DUT. Thus, angled connectors will add to the device PDL.

## 86120D and 86122C Multi-Wavelength Meters

[www.keysight.com/find/mwm](http://www.keysight.com/find/mwm)

- New 86120D replaces 86120B and 86120C, providing faster measurements and better accuracy from 700 - 1650 nm
- Characterize WDM spectra during R&D and manufacturing
- Wavelength accuracy  $< \pm 0.3$  pm with 0.5 s update rate
- Simultaneously measure wavelengths and powers of up to 1000 channels
- Automatic optical signal-to-noise ratio measurements
- Automated measurement routines and data logging

As the demand for access to more information increases, the need for greater capacity on transmission systems drives component manufacturers and network equipment manufacturers to push their capabilities to new limits. The use of tunable transmitters and ROADMs in networks makes accurate and fast measurements of wavelength more critical than ever. With Keysight multi-wavelength meters, you will be able to address these demands with confidence.



### The Performance You Need – When You Need It

The Keysight family of multi-wavelength meters is just that – a family. Each model uses compatible SCPI remote commands. You pay for only the performance you need, when you need it. If your requirements become more demanding in the future, you can substitute another Keysight multi-wavelength meter, avoiding unnecessary cost and time developing new code for your test system. With the 86122C, you can upgrade to a unit with the best performance available. Keysight multi-wavelength meters allow you to optimize test costs while protecting your investments.

### Simultaneously measure up to 1000 wavelengths and powers

The Keysight 86120D and 86122C multi-wavelength meters, like other, Michelson interferometer-based wavelength meters, allow you to measure the average wavelength of the input signal. In addition, the Keysight multi-wavelength meters – with advanced digital processing – accurately and easily differentiate and measure up to 1000 discrete wavelengths.

Keysight multi-wavelength meters simultaneously measure the individual powers of discrete wavelengths, offering the following measurement capabilities:

- 1 to 1000 wavelengths and powers
- Average wavelength and total power
- Up to  $\pm 0.2$  ppm wavelength accuracy
- Up to 5 GHz wavelength resolution
- Calibrated for evaluation in air or vacuum
- Wavelength units in nm, THz, or wave number ( $\text{cm}^{-1}$ )
- Amplitude units in dBm, mW, or  $\mu\text{W}$
- Rugged design to withstand strong shocks and vibrations

### WDM transmission systems

Combining measurement performance with reliability, the Keysight multi-wavelength meters allow easy and accurate verification of optical carrier performance in transmission systems by measuring wavelength, power and optical signal-to-noise ratios during design and manufacturing test. The 86122C multi-wavelength meter is optimized for measuring ultra-dense channel spacing with an absolute wavelength accuracy of up to  $\pm 0.2$  ppm ( $\pm 0.3$  pm referenced to 1550 nm). With a resolution of  $< 5$  GHz, it is an ideal solution for the design and manufacturing of next-generation optical networks.

### Sources

The superior wavelength and amplitude measurement capabilities of the Keysight 86120D and 86122C multi-wavelength meters enable maximum performance of your components. You can measure DFB, FP, iTLA or multiple DFB laser wavelengths and amplitudes during burn-in, environmental evaluation, mode mapping, final test and incoming inspection. Calculate center wavelengths of broader linewidth sources, such as LED's or Bragg-Gratings filtered ASE responses, or modulated sources, using the user-selectable broadband algorithm.

### Features and advanced measurement applications:

- Relative Wavelength and Amplitude Measurements
- Built-in Data Logging
- Drift: Current and Min/Max values
- Optical Signal-To-Noise Ratio
- Fabry-Perot Laser Characterization
- Broadband signal mode

### Instrument drivers

Instrument drivers compatible with LabView, Visual Basic, C++, and LabWindows are available for the Keysight 86120D and 86122C multi-wavelength meters. These drivers enable remote program development by offering building blocks that allow you to customize your measurements.

		86120D	86122C
<b>Maximum number of laser lines input</b>		1000	
<b>Wavelength</b>	Range	700 to 1650 nm (182 to 428 THz)	1270 to 1650 nm (182 to 236 THz)
	Operating range	700 to 1700 nm (176 to 428 THz)	
	Absolute accuracy	± 1.5 ppm, typ. 1 ppm (within 15°C to 35°C) (± 2.3 pm at 1550 nm, ± 2.1 pm at 1310 nm) for laser lines separated by ≥ 20 GHz	± 0.2 ppm (± 0.3 pm at 1550 nm and 1310 nm); for laser lines separated by ≥ 10 GHz
	Differential accuracy <sup>1</sup> minimum resolvable separation (equal power lines input)	± 0.4 ppm 15 GHz (0.12 nm at 1550 nm, 0.09 nm at 1310 nm)	± 0.15 ppm 5 GHz (0.04 nm at 1550 nm; 0.03 nm at 1310 nm)
	Display resolution	0.0001 nm	
	Units	nm (vacuum or standard air), cm <sup>-1</sup> , THz	nm (vacuum or standard air), cm <sup>-1</sup> , THz
<b>Power</b>	Calibration accuracy	± 0.6 dB (at ± 30 nm from 780, <sup>1</sup> 1310, and 1550 nm)	± 0.5 dB (at ± 30 nm from 1310 and 1550 nm)
	Flatness <sup>1</sup> , 30 nm from any wavelength	± 0.2 dB, 1200 to 1600 nm ± 0.5 dB, 700 to 1650 nm	± 0.2 dB, 1270 to 1600 nm ± 0.5 dB, 1270 to 1650 nm
	Linearity, lines above -30 dBm	± 0.3 dB, 1200 to 1600 nm	± 0.3 dB, 1270 to 1600 nm
	Polarization dependence	± 0.6 dB, 1200 to 1600 nm ± 1.5 dB <sup>1</sup> , 700 to 1650 nm	± 0.6 dB, 1270 to 1600 nm ± 1.0 dB <sup>1</sup> , 1600 to 1650 nm
	Units	dBm, mW, μW	
<b>Sensitivity</b> <sup>1</sup>	Single line input	-20 dBm, 700 to 900 nm -25 dBm <sup>1</sup> , 800 to 1200 nm -40 dBm, 1200 to 1600 nm -30 dBm, 1600 to 1650 nm	-32 dBm, 1270 to 1600 nm -22 dBm, 1600 to 1650 nm
	Multiple lines input <sup>1</sup>	30 dB below total input power, but not less than single line	
<b>Selectivity</b>		25 dB spacing ≥ 100 GHz 10 dB spacing ≥ 25 GHz	25 dB spacing ≥ 90 GHz 10 dB spacing ≥ 10 GHz
	<b>Measurement cycle time</b>	0.6 s	0.5 s (86122C-100) 0.3 s (86122C-110)
<b>Input power</b>	Maximum displayed level	+10 dBm (sum of all lines input)	
	Maximum safe input level	+18 dBm (sum of all lines input)	
<b>Built-in automatic measurement applications</b>			
	Signal-to-noise ratio, 100 averages, at 1550 nm, 0.1 nm noise bandwidth, lines above -25 dBm <sup>1</sup>	> 35 dB, channel spacing ≥ 200 GHz	> 35 dB, channel spacing ≥ 100 GHz > 27 dB, channel spacing ≥ 50 GHz
	Drift	Maximum, Minimum, total drift (max-min) wavelengths and powers over time	
	Fabry-Perot characterization <sup>1</sup>	Mean wavelength, peak wavelength, mode spacing full-width half maximum, peak amplitude, total power, sigma	
<b>Reliability</b>	Warranty	3 years standard warranty	5 years standard warranty
	Recommended re-calibration period	2 years	2 years
<b>Laser classification</b>		FDA Laser Class I according to 21 CFR 1040.10; IEC Laser Class 1 according to IEC 60825-1/2007	
<b>Dimensions</b>		138 mm x 425 mm x 520 mm	
<b>HxWxD</b>		(5.4 in x 16.7 in x 20.5 in)	
<b>Weight</b>		14.5 kg (32 lb)	

1. Supplementary performance characteristics provide information about non-warranted instrument performance in the form of nominal values.

2. For lines separated by less than the specified amount, wavelength accuracy is reduced.

## 8157xA High-Power Optical Attenuators

[www.keysight.com/find/voa](http://www.keysight.com/find/voa)

- Low insertion loss of 0.7 dB
- Excellent wavelength flatness
- Coverage in both single mode and multi mode fiber
- High attenuation resolution of 0.001 dB
- Active power control option



### Modular design, fit for various component and network solutions

Keysight's 8157xA variable optical attenuators are a family of plug-in modules for Keysight's lightwave solution platform 8163A/B, 8164A/B and 8166A/B. The attenuator modules 81570A, 81571A and 81578A occupy one slot, while modules 81576A and 81577A occupy two slots. With 17 slots, the Keysight 8166A/B lightwave multichannel system can host up to 17 single slot modules or up to 8 dual slot modules.

### Variable optical attenuators

The Keysight 81570A, 81571A and 81578A are small, cost effective attenuator modules with high resolution. They feature excellent wavelength flatness and can handle high input power levels. Various calibration features allow the user to set a reference power. Both the attenuation and the power level, relative to the reference power, can then be set and displayed in the user interface. An integrated shutter, which can be used for protection purposes, or to simulate channel drops, is available.

### Attenuators for high optical input power

The Keysight modules feature excellent wavelength flatness and can handle high input power levels of 2 mW. Combined with their low insertion loss, they are ideal for optical amplifier tests, such as characterization of EDFAs and of Raman amplifiers, as well as for other multi-wavelength applications, such as DWDM transmission system test.

### Attenuators with power control

Keysight's 81576A and 81577A attenuators feature power control functionality that allows you to set the output power level of the attenuator. The attenuator module firmware uses the feedback signal from a photo diode after a monitor tap, both integrated in the module, to set the desired power level at the output of the module. When the power control mode is enabled, the module automatically corrects power changes at the input to maintain

the output level set by the user. After an initial calibration for the uncertainties at connector interfaces, absolute power levels can be set with high accuracy. The absolute accuracy of these power levels depends on the accuracy of the reference power meter used for calibration.

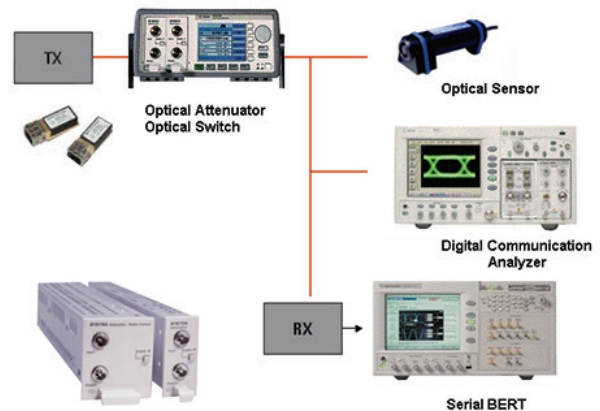

Transceiver and Receiver Test

### Wavelength flatness

The Keysight optical attenuator modules feature excellent wavelength flatness and can handle high input power levels. Combined with their low insertion loss, they are ideal for optical amplifier tests, such as characterization of EDFAs and of Raman amplifiers, as well as for other multi-wavelength applications, such as DWDM transmission system test. One unique feature is a Plug&Play software function which enhances calibration capacity by setting the integral power of a DWDM signal with a known spectrum.

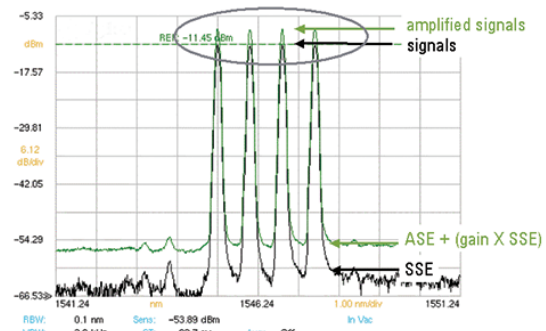

Wavelength flatness preserves multichannel signal flatness for EDFA test.

### Modal fidelity for multimode fiber systems

Signals in multimode fibers are distributed over a range of mode groups that can have different loss and delay in a link. For dependable multimode transceiver testing, the instrument used to set the power level should not change this modal distribution. The bulk-optic filter and collimated beam path of Keysight multimode attenuators are the best way to assure homogeneous attenuation of all input modes.



	8157xA		81578A-050	81578A-062
Connectivity	Straight (81570A) / Angled (81571A) Flexible connector interface		Straight (81576A) / Angled (81577A) Flexible connector interface	
Fibre type	9/125 $\mu$ m SMF28	9/125 $\mu$ m SMF	50/125 $\mu$ m MMF	62.5/125 $\mu$ m MMF
Wavelength range	1200 to 1700 nm		700 to 1400 nm	
Attenuation	0 to 60 dB		0 to 60 dB	
Resolution	0.001 dB		0.001 dB	
Repeatability <sup>1</sup> (Attenuation setting)	0.01 dB		$\pm$ 0.015 dB <sup>13,15</sup>	
Repeatability <sup>1</sup> (Power setting)			$\pm$ 0.015 dB <sup>2</sup>	
Accuracy (uncertainty) <sup>1,3</sup> (Attenuation setting)	$\pm$ 0.1 dB <sup>4,5</sup>		Typ. $\pm$ 0.15 dB (800 to 1350 nm) $\pm$ 0.2 dB (at 850 nm $\pm$ 15 nm, 1310 nm $\pm$ 15 nm) <sup>13,14</sup>	
Settling time (typ.) <sup>23</sup> (Attenuation setting)	100 ms		100 ms	
Settling time (typ.) <sup>23</sup> (Power setting)			300 ms	
Transition speed (typ.)	0.1 to 12 dB/s		0.1 to 12 dB/s	
Relative power meter uncertainty <sup>16,17</sup>	N/A		$\pm$ 0.03 dB $\pm$ 200 pW <sup>16</sup>	
Attenuation flatness <sup>1,5,7,9</sup>	< $\pm$ 0.07 dB (typ $\pm$ 0.05 dB) for 1520 to 1620 nm typ. $\pm$ 0.10 dB for 1420 to 1640 nm		N/A N/A	
Spectral ripple (typ.) <sup>8</sup>	$\pm$ 0.003 dB		$\pm$ 0.003 dB	
Insertion loss <sup>3,5</sup>	Typ. 0.7 dB (excluding connector) 1.6 dB typ. 1.0 dB (including connectors) <sup>10,13</sup>	Typ. 0.9 dB (excluding connectors) 1.8 dB typ. 1.2 dB (including connectors) <sup>10,12</sup>	Typ. 1.0 dB (NA = 0.1) Typ. 1.3 dB (NA = 0.2) 2.0 dB (NA = 0.2) <sup>13,15</sup>	Typ. 1.0 dB (NA = 0.1) Typ. 1.3 dB (NA = 0.2) 2.0 dB (NA = 0.2) <sup>13,15</sup> Typ. 3.0 dB (NA = 0.27)
Insertion-loss flatness (typ.) <sup>1,12,5</sup>	$\pm$ 0.1 dB for 1420 to 1615nm		N/A	
Polarization-dependent loss <sup>3,10,12</sup>	< 0.08 dBpp (Typ. 0.03 dBpp)		< 0.10 dBpp (typ. 0.05 dBpp)	
Return loss (typ.)	45 dB (81570A) / 57 dB (81571A) <sup>10,12</sup>		45 dB (81576A)/ 57 dB (81577A) <sup>10,12</sup>	
Maximum input power <sup>14</sup>	+33 dBm		+33 dBm	
Shutter isolation (typ.)	100 dB		100 dB	
Dimensions (H x W x D)	75 mm x 32 mm x 335 mm (2.8" x 1.3" x 13.2")		75 mm x 32 mm x 335 mm (2.8" x 1.3" x 13.2")	
Weight	0.9 kg		1.3 kg	
Recommended recalibration period	2 years		2 years	
Operating temperature	10 to 45 °C		10 to 45 °C	
Humidity	Non-condensing		Non-condensing	
Warm-up time	30 minutes		30 minutes	

1. At constant temperature.

2. Output power > -40 dBm, input power < +27 dBm. For input power > +27 dBm add typ.  $\pm$  0.01 dB.

3. Temperature within 23  $\pm$  5 °C.

4. Input power < +30 dBm; 1550 nm  $\pm$  15 nm; typ. for 1250 nm <  $\lambda$  < 1650 nm.

5. For unpolarized light

6. Stepsize < 1 dB; for full range: typ. 6 s.

7. Relative to reference at 0 dB attenuation.

8. Linewidth of source  $\geq$  100 MHz.

9. For  $\lambda_{disp}$  set to 1550 nm and attenuation  $\leq$  20 dB; for higher attenuation add 0.01 dB per add. dB for 1520 to 1620 nm and 0.02 dB/dB for 1450 to 1640 nm.

10. For 1550 nm  $\pm$  15 nm.

11. Add typ. 0.1 dB for 1310 nm  $\pm$  15 nm.

12. Measured with Keysight reference connectors.

13. Effective spectral source bandwidth > 5 nm

14. For input mode conditions NA = 0.2; for additional  $\Delta$ NA = 0.01, add  $\pm$  0.01 dB typ.

15. At 850  $\pm$  15 nm or 1310  $\pm$  15 nm

**Ordering information:** For the most up-to-date information on Keysight optical attenuators, please contact your Keysight Technologies sales representative or visit our web site at: [www.keysight.com/find/lightwave](http://www.keysight.com/find/lightwave)

**Connector interface:** All modules require two connector interfaces, 81000xl series (physical contact).

### N775xA and N776xA Optical attenuators

- 0.05 dB relative power setting accuracy
- Settling time: 20 ms attenuation, 100 ms power, 200 ms
- Miniature bulk optic for best multimode transfer distribution
- 0.1 to 1000 dB/s or for multimode to 0.1 to 80 and 1000 dB/s attenuation transition speed (selectable)
- +23 dBm max. input power,  $\leq 1.2$  dB insertion loss
- 45 dB single-mode attenuation range (typ.)
- 35 dB multimode attenuation range
- -50 to +20 dBm power setting range
- Fully compatible with setups and programs developed using the Keysight 8157x modular attenuators
- Two instrument configurations can be stored and recalled

The Keysight N775xA and N776xA series compact multichannel attenuators and power meters are a new class of remote controlled fiber optic instruments for optical transceiver and network integration test. All attenuators include an internal power monitor for each channel to reduce the complexity of closed-loop setups like those needed for very accurate BER testing or eye mask analysis by allowing power to be set directly rather than needing to set an attenuation value. All attenuators feature both attenuation mode and power control mode: In attenuation mode, the calibrated value of attenuation in dB can be set. The rate of attenuation change during setting can be adjusted between 0.1 and 80 dB/s or set to 1000 for multimode and adjusted from 0.1 to 1000 dB/s for single mode. In power control mode, the instrument uses its integrated power monitor to set the desired power level at the output of the module. It automatically corrects for input power changes so that the output power level is maintained. Absolute power levels can be set with high accuracy after an initial offset calibration.

### Modal fidelity for multimode fiber systems

Signals in multimode fibers are distributed over a range of mode groups that can have different loss and delay in a link. For dependable multimode transceiver testing, the instrument used to set the power level should not change this modal distribution. The bulk-optic filter and collimated beam path of Keysight multimode attenuators are the best way to assure homogeneous attenuation of all input modes.

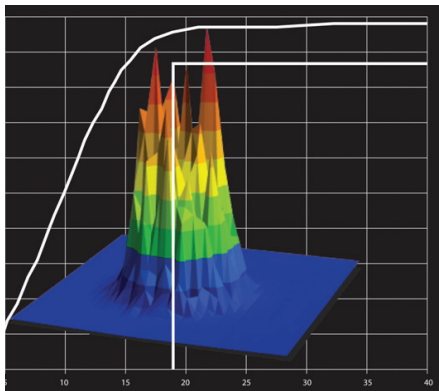

### N776xA multi-channel optical attenuators with internal power control



1-channel variable attenuator N7761A



2-channel N7762A SMF attenuator or N7766A MMF attenuator



4-channel N7764A SMF attenuator or N7768A MMF attenuator

### N775xA multi-channel optical attenuators with internal power control and external power meter channels.

The 2 integrated power meters in the N7751A and N7752A allow convenient measurement of optical power from different stages of the test setup and provide a very convenient and automatic way to calibrate the attenuator power reading to the power actually present at another point, such as the input to the receiver under sensitivity test. This calibration can thus correct for insertion loss due to switches and other components between the attenuator and the point of interest.



1-channel attenuator with two power meter channels N7751A



2-channel attenuator with two power meter channels N7752A

N7751A, N7752A, N7761A, N7762A, N7764A			N7766A and N7768A	
Connectivity	FC/APC angled (Option -022) or FC/PC straight (Option -021) contact connector interface		FC/PC straight contact connector interface	
Fiber type	9/125 μm SMF 28		50 μm (Option 050) or 62.5 μm (Option 062) or 80 μm (Opt. 080) core MMF	
Wavelength range	1260 to 1640 nm		800 to 1370 nm	
Attenuation range	0 to 40 dB (45 dB typ.)		0 to 35 dB	
	Attenuation setting mode	Power setting mode	Attenuation setting mode	Power setting mode
Range	0 to 40 dB	-50 to +20 dBm	0 to 35 dB	-35 to +20 dBm
Resolution	0.01 dB	0.01 dB	0.03 dB	0.03 dB
Repeatability	Typ. ± 0.05 dB for attenuation 0 to 30 dB Typ. ± 0.10 dB for attenuation 30 to 40 dB	± 0.025 dB	± 0.05 dB	± 0.05 dB
Accuracy (uncertainty)	Typ. ± 0.10 dB for attenuation 0 to 10 dB Typ. ± 0.15 dB for attenuation 10 to 20 dB Typ. ± 0.40 dB for attenuation 20 to 40 dB		Typ. ± 0.40 dB	
Relative accuracy (uncertainty)	± 0.05 dB ± 300 pW		± 0.1 dB ± 300 pW	
Polarization dependent loss	Typ. ≤ 0.15 dBpp for attenuation 0 to 10 dB Typ. ≤ 0.25 dBpp for attenuation 10 to 20 dB Typ. ≤ 0.5 dBpp for attenuation 20 to 40 dB		≤ 0.15 dBpp	
Settling time	Typ. 20 ms*	Typ. 100 ms*	Typ. 200 ms	Typ. 200 ms
Insertion loss	Typ. ≤ 1.2 dB (excluding connectors) ≤ 2.2 dB (including connectors)*		Typ. ≤ 1.0 dB (excluding connectors) ≤ 2.0 dB (including connectors)*	
Attenuation transition speed	Selectable from 0.1 to 1000 dB/s		Selectable from 0.1 to 80 or at > 500	
Relative uncertainty of monitor power meter	± 0.05 ± 300 pW		± 0.1 ± 300 pW	
Averaging time of monitor power meter	2 ms to 1 s		2 ms to 1 s	
Return loss	Typ. 45 dB		Typ. 25 dB	
Maximum safe input power	+23 dBm if applied to input port; or +18 dBm if applied to output port		+23 dBm	
Optical path blocking	Typ. 45 dB		Typ. 60 dB	

N7751A and N7752A	
Sensor element	InGaAs
Wavelength range	1260 to 1640 nm
Specification wavelength range	(1310 ± 15) nm, (1490 ± 10) nm, (1550 ± 15) nm
Power range	-80 to +10 dBm
Maximum safe power	+16 dBm
Averaging time	2 ms to 1 s
Applicable fiber type	Standard SM and MM ≤ 62.5 μm core size, NA ≤ 0.24
Uncertainty at reference conditions	± 2.5%
Total uncertainty	± 4.5%
Linearity at (23 ± 5)°C	± 0.02 dB
Linearity* over operating temperature	± 0.04 dB
Polarization dependent responsivity (PDR)	Typ. < ± 0.01 dB (1260 to 1580 nm)
Spectral ripple (due to interference)	Typ. < ± 0.01 dB
Drift (dark)	± 9 pW
Noise pp (dark)3, (1 s averaging time, 300 s observation time)	< 7 pW
Return loss	Typ. > 57 dB

For the most up-to-date information on Keysight optical attenuators, please contact your Keysight Technologies sales representative or visit our web site at: [www.keysight.com/find/lightwave](http://www.keysight.com/find/lightwave)

## 81595B, N7731A and N7734A Optical Switch

[www.keysight.com/find/oct](http://www.keysight.com/find/oct)

- Excellent repeatability, specified over 10,000 random cycles
- Low insertion loss and polarization dependence
- Single-mode or multimode
- Single 1x4, dual 1x4 and single 1x13



### Switching reduces uncertainty from connections and eases test automation

These instruments and modules are used for automatic routing of optical signals for testing devices like transceivers, amplifiers, and passive components. Optical switches optimize the investment in automated test equipment by improving repeatability and throughput and supporting parallel measurements of multiport and multiple devices.

The low IL and PDL and high repeatability assure minimum impact of the switch on measurement accuracy.

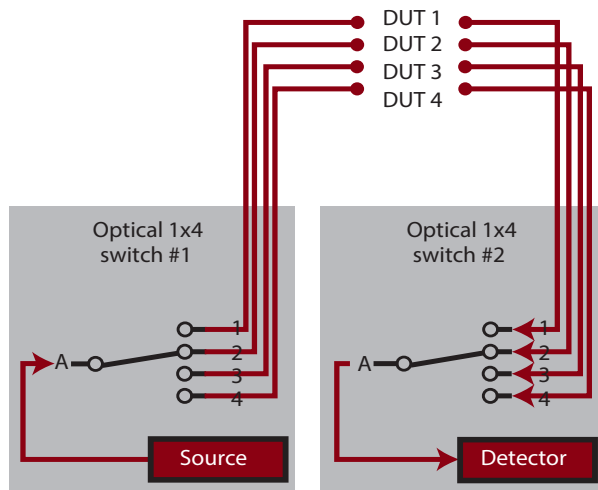

Switching can be performed from the button on the module, from the mainframe interface and via GPIB control. The compact form and high performance allow combining switches for multistage setups, like five 1x4 modules.

### Modal fidelity for multimode fiber systems

Signals in multimode fibers are distributed over a range of mode groups that can have different loss and delay in a link. For dependable multimode transceiver testing, the instrument used to set the power level should not change this modal distribution. The Keysight multimode switches are designed with very short collimated paths between fiber, so signals propagate in practically the same distribution as through uninterrupted multimode fiber.

### Modular optical switch specifications

81595B		
Switch type	1x4	
Fiber interface	# 009 single mode	# 062 multimode
Fiber type	9/125 $\mu\text{m}$ SMF	62.5/125 $\mu\text{m}$ MMF
Connectivity	FC/APC angled, narrow key	FC/PC straight
Wavelength range	1270 to 1670 nm	700 to 1400 nm
Repeatability <sup>2</sup>	$\pm 0.03$ dB	$\pm 0.03$ dB
Insertion loss	< 1.25 dB	< 1.0 dB
Polarization dependent loss	typ. 0.07 dB <sub>pp</sub>	N/A
Return loss	typ. 55 dB	typ. 20 dB
Crosstalk	typ. -70 dB	typ. -70 dB
Switching time	< 10 ms	
Lifetime	> 10 million cycles	
Maximum input power	+20 dBm	

N7731A		
Switch type	Dual 1x4	
Fiber interface	# 009 single mode	# 062 multimode
Fiber type	9/125 $\mu\text{m}$ SMF	62.5/125 $\mu\text{m}$ MMF
Connectivity	FC/APC angled, narrow key	FC/PC straight
Wavelength range	1250 to 1650 nm	600 to 1700 nm
Repeatability <sup>2</sup>	$\pm 0.01$ dB, $\pm 0.004$ dB typ.	$\pm 0.01$ dB <sup>1</sup> , $\pm 0.004$ dB typ.
Insertion loss	< 2.0 dB, < 1.5 dB typ.	< 1.0 dB <sup>1</sup> , < 0.5 dB typ.
Polarization dependent loss	Typ. 0.07 dB <sub>pp</sub>	N/A
Return loss	Typ. 55 dB	Typ. 35 dB
Crosstalk	Typ. -65 dB	Typ. -65 dB <sup>4</sup>
Switching time	< 20 ms	
Lifetime	> 1 billion cycles	
Maximum input power	+23 dBm	

N7734A		
Switch type	1x13	
Fiber interface	# 009 single mode	# 062 multimode
Fiber type	9/125 $\mu\text{m}$ SMF	62.5/125 $\mu\text{m}$ MMF
Connectivity	FC/APC angled, narrow key	FC/PC straight
Wavelength range	1250 to 1650 nm	600 to 1700 nm
Repeatability <sup>2</sup>	$\pm 0.01$ dB, $\pm 0.004$ dB typ.	$\pm 0.01$ dB <sup>1</sup> , $\pm 0.004$ dB typ.
Insertion loss	< 2.5 dB, < 2.2 dB typ.	< 1.2 dB, < 0.7 dB typ.
Polarization dependent loss	Typ. 0.12 dB <sub>pp</sub>	N/A
Return loss	Typ. 55 dB	Typ. 30 dB
Crosstalk	Typ. -60 dB	Typ. -55 dB
Switching time	< 20 ms	
Lifetime	> 1 billion cycles	
Maximum input power	+23 dBm	

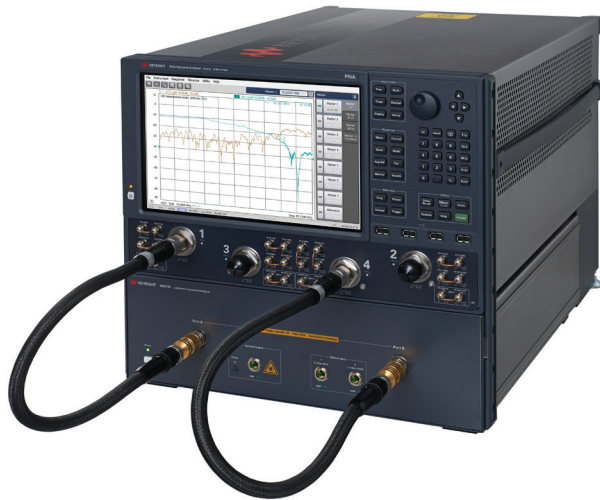

The N4373E offers the latest N5227B series network analyzers with 2-port or 4-port configuration. This LCA is the ideal measurement solution for test of electro-optical components up to 67 GHz. It is the ideal test instrument for electro-optical components for 64 Gbaud PAM-4 and coherent transmission, as well as Radio over Fiber (RoF) and aerospace and defense electro-optical test applications.

The N4373E is traceable to international standards and provides guaranteed specifications for electro-optical responsively S-parameter measurements in a turn-key solution. In combination with N4694A electronic calibration kit you get fastest setup of your test, so you can focus on developing your components.

Fast and easy measurement setup increases productivity as time-consuming electrical calibration steps are automated and optical calibration by the operator is no longer necessary.

## Features

- Built-in average power meter for fast transmitter power test
- SCPI remote control
- External tunable laser input for 1260 - 1640nm receiver test.
- User selectable optical transmitter output power helps to adapt to target test conditions

## Absolute frequency response accuracy

- < 0.9 dBe at 50 GHz (typ.)
- < 1.3 dBe at 67 GHz (typ.)

## Relative frequency response accuracy

- < 0.5 dBe at 50 GHz (typ.)
- < 1.3 dBe at 67 GHz (typ.)

## Noise floor 26.5 GHz

- < -59 dB (W/A) at 67 GHz for E/O measurements
- < -55 dB (A/W) at 67 GHz for O/E measurements

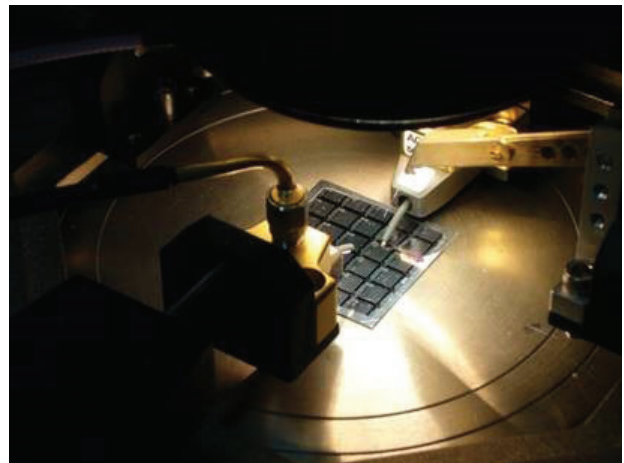

Photo detector wafer probing

## Benefits

- Design assurance with fast, accurate and complete measurements
- Quick time-to-market with fast test turnaround
- Protected investment with flexibility to add and change options and wavelength range
- Efficient use of measurement time with intuitive and powerful user interface and measurements at the touch-of-a-button
- Confident and easy analysis with built-in smoothing and fitting tools
- High uptime with worldwide service and support Easy data transfer with LAN and USB connectivity
- Optimized use of time with programmable automation

## Special option available on request

- Multimode fiber component S-parameter test up to 55 GHz @ 850nm. Other wavelengths upon request.
- Integration of PNA-X network analyzers 55 GHz @ 850nm.

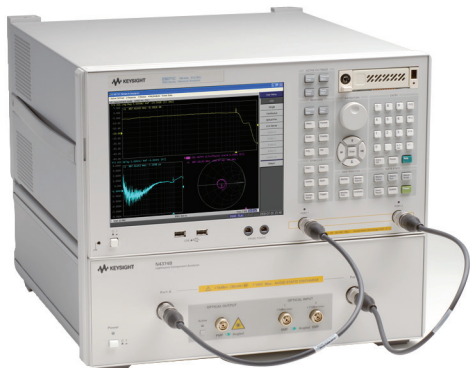

The new N4374B lightwave component analyzer (LCA) is the successor of the 8702 LCA with target application in CATV and Radio over Fiber (RoF). It is based on ENA-C series network analyzers. CATV is supported by offering a 75  $\Omega$  referenced measurement. To do this a minimum loss pad is included to adapt from 50  $\Omega$  to 75  $\Omega$ . With the adapter removal tool included in the ENA all test results show the correct 75  $\Omega$  referenced results.

With up to 4.5 GHz modulation frequency range electro-optical S-parameter tests for 3G and LTE RoF applications are well supported. Traceable specifications for relative and absolute responsivity make the tests results independent of the instrument personality that makes the test results comparable between supplier and vendor or between various locations.

It's the excellent accuracy and repeatability that improves yield from tests performed with the N4374B, by narrowing margins needed to pass the tested devices resulting in improved manufacturing yield. The turn-key solution offers fastest time to market. With the more than 3 times faster tests compared to the 8702 series this LCA helps to significant reduce manufacturing cost.

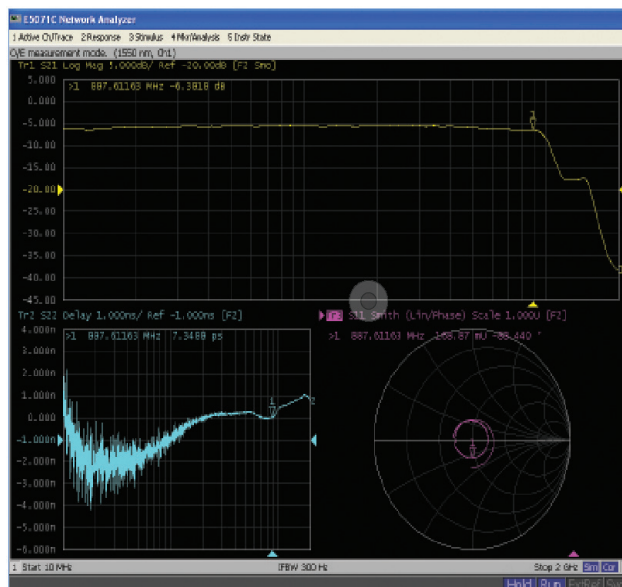

#### Key benefits

- High absolute and relative accuracy measurements improve the yield of development and production processes
- Support of 75  $\Omega$  devices
- Significantly increased productivity using fast and easy measurement setup with a unique new calibration process leads to lower cost of test
- Identical LCA software and remote control across the N437xB/C family simplifies integration
- Transmitter wavelength 1550 nm and/or 1310 nm
- Built-in optical power meter
- Settable transmitter output power
- External optical input option
- Integrated Bias-T option in ENA

#### System performance extract (typical data @1550 nm)

		100 kHz to 0.7 GHz	0.7 GHz to 4.5 GHz
Relative frequency response uncertainty	E/O	$\pm 0.7$ dBe	$\pm 0.5$ dBe
	O/E	$\pm 0.7$ dBe	$\pm 0.5$ dBe
Absolute frequency response uncertainty	E/O	$\pm 1.7$ dBe	$\pm 1.5$ dBe
	O/E	$\pm 1.7$ dBe	$\pm 1.5$ dBe
Frequency response repeatability	E/O, O/E	$\pm 0.02$ dBe	$\pm 0.02$ dBe
Noise floor	E/O	-60 dB (W/A)	-80 dB (W/A)
	O/E	-50 dB (A/W)	-70 dB (A/W)
Phase uncertainty (typ.)	E/O	-	$\pm 2.0^\circ$
	O/E	-	$\pm 2.0^\circ$

Group delay uncertainty

Derived from phase uncertainty, see section "Group delay uncertainty".

Example:  $\pm 2.0^\circ \rightarrow \pm 8$  ps (1 GHz aperture)



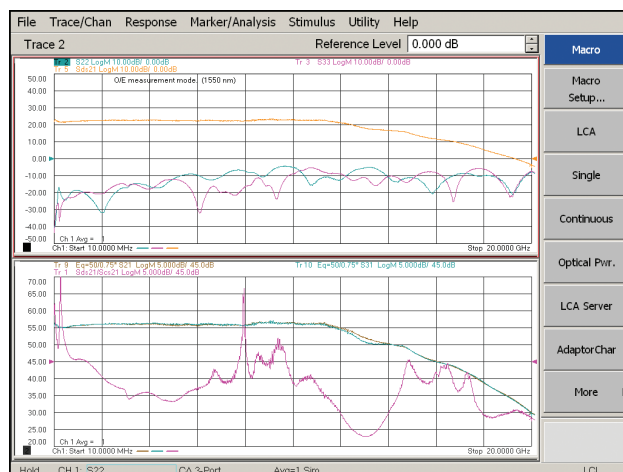
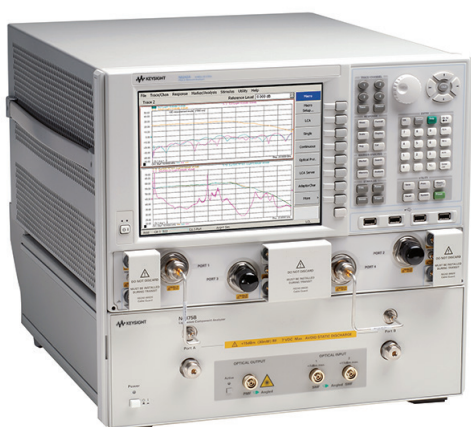

Keysight's N4375D lightwave component analyzer (LCA) is the successor of the industry standard 8703A/B LCA. Its target application is the test of electro-optical components for 10 GbE, Fibre Channel FCx8, FCx10 and FCx16.

With a completely new design of the optical test set and a new RF-switched architecture, together with the latest PNA family of network analyzers, the N4375D guarantees excellent electro-optical measurement performance. In addition a unique new calibration concept significantly reduces time from powering up the LCA until the first calibrated measurement can be made. This increases productivity in R&D and on the manufacturing floor.

The fully integrated "turnkey" solution reduces time to market, compared to the time-consuming development of a selfmade setup. By optimizing the electrical and optical design of the N4375D for lowest noise and ripple, the accuracy has been improved by more than a factor of 3 and is now independent of the electrical return loss of the device under test. It is the excellent accuracy that improves the yield from tests performed with the N4375D, by narrowing margins needed to pass the tested devices. NIST traceability ensures worldwide comparability of test results.

### Key benefits

- High absolute and relative accuracy measurements improve the yield of development and production processes
- High confidence and fast time-to-market with a NIST traceable turnkey solution
- Significantly increased productivity using the fast and easy measurement setup with a unique new calibration process leads to lower cost of test
- More than 3 times faster than predecessor 8703A/B series speeds up every test procedure
- New switched architecture of optical test set for long term reliability and stability of test results
- Identical LCA software and remote control across the N437xx family simplifies integration

### Key features

- Transmitter wavelength 1550 nm and/or 1310 nm
- Built-in optical power meter
- Settable transmitter output power
- External optical source input option

System performance extract (typical data @1550 nm)		0.05 GHz to 0.2 GHz	0.2 GHz to 0.7 GHz	0.7 GHz to 20 GHz
Relative frequency response uncertainty	E/O	± 0.7 dBe	± 0.5 dBe	± 0.5 dBe
	O/E	± 0.7 dBe	± 0.5 dBe	± 0.5 dBe
Absolute frequency response uncertainty	E/O	± 1.7 dBe	± 1.5 dBe	± 1.5 dBe
	O/E	± 1.7 dBe	± 1.5 dBe	± 1.5 dBe
Frequency response repeatability	E/O, O/E	± 0.02 dBe	± 0.02 dBe	± 0.05 dBe
Noise floor	E/O	-60 dB (W/A)	-86 dB (W/A)	-86 dB (W/A)
	O/E	-49 dB (A/W)	-72 dB (A/W)	-74 dB (A/W)
Phase uncertainty (typ.)	E/O	-	± 2.0°	± 2.0°
	O/E	-	± 2.0°	± 2.0°
Group delay uncertainty	Derived from phase uncertainty, see section "Group delay uncertainty". Example: ± 2.0° → ± 8 ps (1 GHz aperture)			

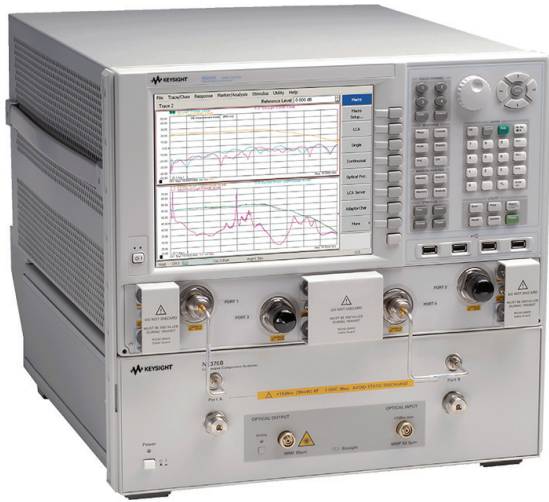

Keysight's N4376D multimode lightwave component analyzer (LCA) operates at 850 nm to characterize short wavelength 10 GbE, Fibre Channel FCx8, FCx10 and FCx16 electro-optical components, with up to 20 or 26.5 GHz modulation range. The N4376D also supports the test of transmitter and receivers for ultra fast optical computer or server backplanes and optical chip-to-chip connections in high speed computers and server applications. With a completely new design of the optical test set and a new RF-switched architecture, together with the latest PNA family of network analyzers, the N4376D guarantees excellent electro-optical measurement performance. In addition a unique new calibration concept significantly reduces time from powering up the LCA until the first calibrated measurement can be made. This increases productivity in R&D and on the manufacturing floor.

Multimode measurements are typically much more critical regarding repeatability and stability than single-mode measurements. A well defined and stable launch condition increases measurement repeatability. The N4376D has typical multimode launch conditions as defined by the IEEE 802.3ae standard, resulting in application realistic and repeatable test results.

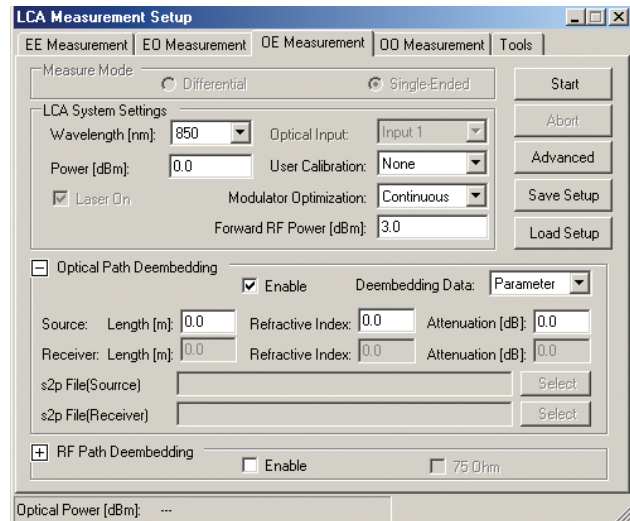

### Key benefits

- Traceable multimode S21 test at 850 nm wavelength
- IEEE 802.3ae launch power distribution leads to test results comparable to the final application
- Fast and easy measurement setup and calibration for all standard tests
- High confidence and fast time-to-market with a traceable turn-key solution
- Significantly increased productivity using the fast and easy measurement setup with a unique new calibration process leads to lower cost of test
- Test right at target launch condition eliminates test uncertainty
- Identical LCA software and remote control across the N437xB/C family simplifies integration
- LC or SC straight connectors
- Built-in optical power meter for fast transmitter power verification
- Powerful remote control with state of the art programming interface based on Microsoft NET or COM
- Identical LCA software and remote control across the N437xx family simplifies integration

### System performance extract (typical data @ 850 nm)

		0.05 GHz to 0.2 GHz	0.2 GHz to 10 GHz	10 GHz to 26.5 GHz
Relative frequency response uncertainty	E/O	± 1.3 dBe	± 1.3 dBe	± 1.6 dBe
	O/E	± 1.3 dBe	± 1.3 dBe	± 1.6 dBe
Absolute frequency response uncertainty	E/O	± 2.0 dBe	± 2.0 dBe	± 2.0 dBe
	O/E	± 1.7 dBe	± 2.0 dBe	± 2.0 dBe
Frequency response repeatability	E/O, O/E	± 0.2 dBe	± 0.1 dBe	± 0.1 dBe
Noise floor	E/O	-50 dB (W/A)	-70 dB (W/A)	-70 dB (W/A)
	O/E	-40 dB (A/W)	-60 dB (A/W)	-60 dB (A/W)



[www.keysight.com/find/m8290a](http://www.keysight.com/find/m8290a)

The compact and modular approach makes the M8290A optical modulation analyzer and high-speed digitizer test solution an ideal system for coherent transmitter signal qualification for EVM and related parameters as well as for coherent optical device characterization including assemblies like ICR, PMQ, CDM, IC-TROSA or ACO

- Ideally suited for 400G coherent transmission test
- Compact and flexible AXIe modular form factor
- 74 Gbaud maximum symbol rate
- 83 to 92 GSa/s sample rate
- 512k samples maximum record length
- 8 bit ADC resolution
- Turn-key solutions for testing coherent optical devices

### Modular concept

The modular concept addresses the needs of development teams, new product introduction groups and production test engineers looking for affordable test equipment for 400G.

### Combination of optical modulation analyzer and high-speed digitizer

The M8290A optical modulation analyzer and high-speed digitizer test solution provides a combination of compactness, affordability and performance that cannot be achieved with current oscilloscope-based solutions in this speed class.

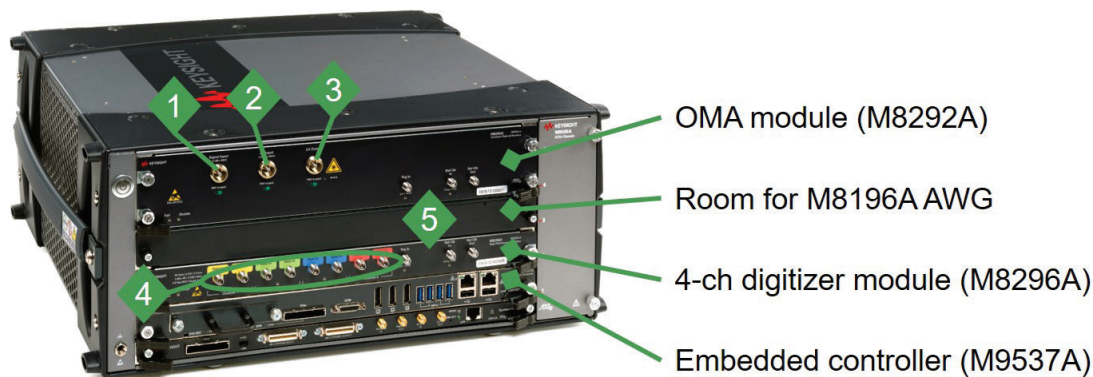

- |                               |                                      |
|-------------------------------|--------------------------------------|
| 1 Optical signal input        | 4 Four differential RF signal inputs |
| 2 Optional external LO input  | 5 Trig In, Ref Clk In, Ref Clk Out   |
| 3 Optional internal LO output |                                      |

- Advanced research for 400 G / 1T and beyond
- Ideal for research on super-channels
- Full C and L-band support
- Based on 90000-Z series oscilloscopes with industry-leading signal integrity
- Polarization analysis
- Support of more than 30 modulation formats
- Adaptive equalization
- Custom OFDM and Custom IQ demodulator available



Unlike the high-speed optical networks of the past, where modulating an optical wave's amplitude on and off at high rates was sufficient, today's optical links are following the wireless industry's lead to high order modulation formats. Complex modulation formats extend beyond on-off keying by encoding communication symbols with both amplitude and phase information. The N4391A optical modulation analyzer is optimized for analysis of these kinds of new optical modulation formats. It is the ideal instrument for advanced research on higher than 112 Gbit/s transmission speeds.

#### Features and benefits

- Wide-bandwidth time-domain polarization-diverse coherent optical receiver, for state-of-the-art advanced modulation format analysis
- Performance verification within minutes for highest reliability of your test results
- One SW platform for entire OMA portfolio
- Well defined interface to include your own MATLAB algorithms
- Fully calibrated system to reveal raw signal performance
- Real-time sampling for optimal phase tracking
- Highest flexibility, with numerous modulation formats, analysis tools and instrument configurations
- No clock input or hardware clock recovery necessary
- Long pattern analysis available
- Flexible hardware and software concept for future adoption to new requirements and investment protection
- CD and first order PMD measurement and compensation for link tests with vector modulated signals

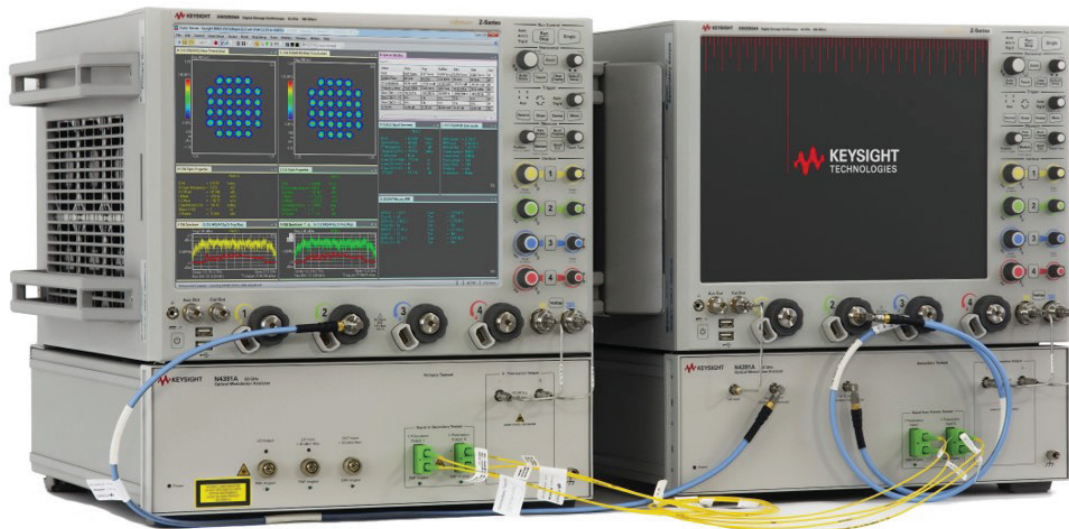



- Real-time bandwidth of up to 63 GHz
- One frame can host four 33 GHz channels and two 63 GHz channels
- The industry's lowest noise and jitter measurement floor
- The industry's deepest memory

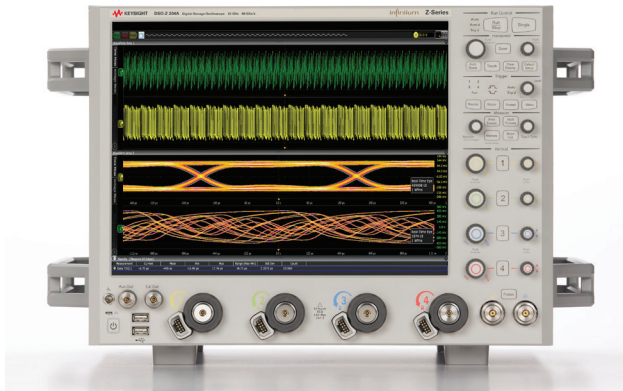

The Infiniium Z-Series oscilloscope

At the extremes of electrical and optical measurements, the right oscilloscope will help you explore the “what” and understand the “why”.

That’s the idea behind Z-Series oscilloscopes, our latest step forward in the application of Keysight’s microwave expertise to real-time oscilloscopes. With its wide bandwidth, the Z-Series lets you see your fastest signals as they really are. Equip your lab with Z-Series scopes.

### Specifications

- 63 GHz analog bandwidth
- 2 channel sample rate: 160 GSa/s
- 4 channel sample rate: 80 GSa/s
- 2 Gpts of memory per channel
- > 20 GHz edge trigger bandwidth
- 30 GHz probing system

### Features and benefits

- Up to 33 GHz true analog bandwidth on four channels in a single frame
- Up to 63 GHz true analog bandwidth on four channels in two synchronized frames
- With the N4391A, up to 120 Gbaud symbol rate analysis
- Four times better EVM noise floor than typical QPSK transmitter
- Compact four channels in turn-key solution
- 4 x 80 GSa/s real-time sampling for optimal phase tracking

### Next generation optical communications research

Z-Series oscilloscopes are also available in combination with the N4391A optical modulation analyzer as a fully specified turn-key instrument. This compact solution offers the highest bandwidth available on the market and is the most advanced test solution for advanced research on 400G / 1T and beyond transmission.

Even for the lower 20 GHz bandwidth range, this compact and easy-to-use solution is a reference system for 100 G transmission required by R&D labs working at 100 G and beyond.

If you prefer to operate with your own optical receivers but want to benefit from the enormous analysis capability, you can get the N4391A’s analysis software as a standalone package.

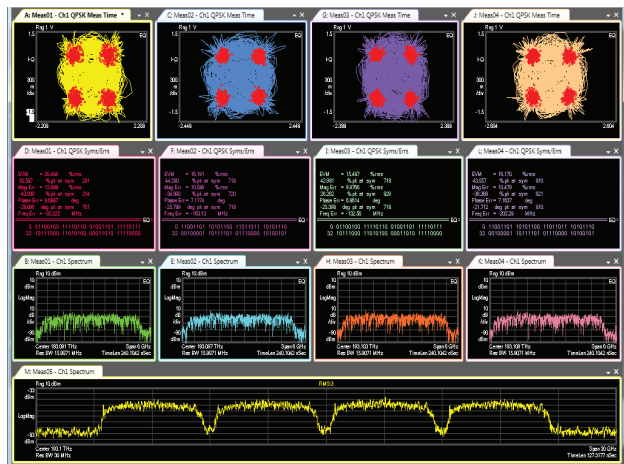

The N4391A based on Z-Series oscilloscope is the tool of choice for 400G multi carrier signal analysis offering up to 126 GHz optical span analysis

### Configuring systems with high channel counts

Two oscilloscope ADC channels are required to measure the I and Q vector components of a single-polarization coherent optical channel. Capacity of systems can be further increased by modulating orthogonal polarizations and/or multiple core fibers. For each additional effective carrier, another pair of oscilloscope channels is required. The Keysight Z-Series can be configured with four channels, each with 33 GHz of bandwidth.

For applications requiring wider bandwidths, over 60 GHz can be achieved in two channels. To increase the channel count or to create more than two channels with over 60 GHz of bandwidth, it is possible to gang together multiple oscilloscopes. Through tying together each oscilloscope on a common 10 MHz or 100 MHz reference, the overall system can be synchronized with a channel-to channel timing uncertainty less than 150 fs.

## N4392A Portable Optical Modulation Analyzer

[www.keysight.com/find/n4392a](http://www.keysight.com/find/n4392a)

- 40/100/200 G coherent transmission test
- Coherent transmitter characterization
- Intradyme Coherent Receiver Test (ICR) test application
- Test solution for coherent optical transmit and receive devices
- Coherent transmission link test
- Error vector analysis capabilities
- Less than 13 kg (28.7 lbs.)
- Built-in calibration
- Built-in performance verification
- Built-in high-performance digitizer

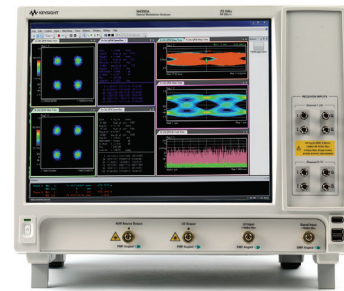

### Compact

Integration of a digitizer, optics and analysis PC leads to a compact turn-key instrument. It also avoids any external cabling, making the instrument robust and easy to set up wherever needed.

Despite the smaller size, the new N4392A offers a big laptop-size screen, giving you more insight in your signal for understanding and debugging your signals even faster.

### Portable

The integration in a compact mid-size oscilloscope housing results in a lightweight instrument, which can be easily moved to any location in a lab or on the manufacturing floor. Operators who need to analyze and debug signals at the physical layer will enjoy this feature as well.

### Affordable

The N4392A is designed for best price-performance balance, achieved by combining advanced integration technologies with built-in calibration and performance verification tools. This leads to longer intervals between recalibration, extending uptime in research and manufacturing and resulting in reduced cost of ownership without leaving any doubt about the performance of the instrument.



You will no longer have to share an optical modulation analyzer among colleagues or even departments because of its high initial investment price.

You will no longer have to move your device under test to another location because it's too hard to move the analyzer, just to perform a short measurement.

You will no longer have to ship your optical modulation analyzer to service once a year for performance verification and recalibration. Now the instrument does all this for you whenever you think it is necessary, increasing the time you can use your instrument.

The N4392A is the next generation of optical modulation analyzers in a compact housing of a mid-size oscilloscope. With 15" screen size, even more analysis parameters can be visualized at the same time, leading to faster debugging results.





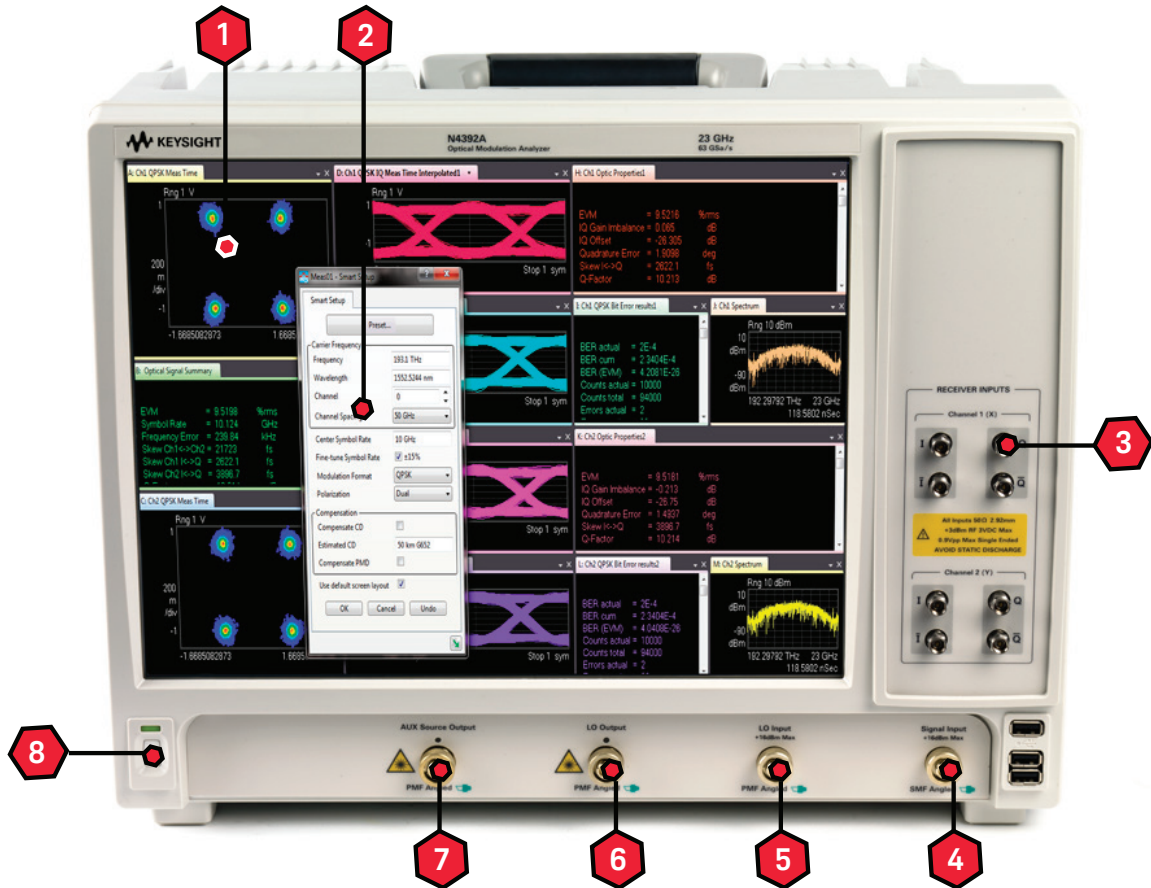

### 1. Vector signal analysis

Like the N4391A, the N4392A is based on the Keysight 89601B vector signal analysis software which is extended for optical requirements. One software platform ensures exchangeability of setting files and measurement results between R&D and manufacturing. This also makes results comparable and exchangeable.

### 2. Predefined setups

For easiest setup of standard 40 G, 100 G and 200 G modulation formats.

### 3. RF inputs

Characterize and evaluate your own IQ demodulator with four differential RF digitizer inputs as required for OIF compliant integrated coherent receivers. (Option 310)

### 4. Signal input

Feed in your signal under test at this input, for modulation analysis that gives you the highest confidence in your test results.

### 5. LO input

In experiments where an extremely stable local oscillator with linewidth in the low kHz range is required, this input can be used as Local oscillator (LO) input for external lasers. (Option 320)

### 6. LO output

Get part of the local oscillator signal to the output for monitoring or setting up a homodyne experiment. (Option 320)



### 7. AUX source output



This output provides you with a CW laser signal which can be used to drive your transmitter or use it as an auxiliary output to calibrate an external integrated IQ demodulator. (Option 320)

### 8. Power ON/OFF

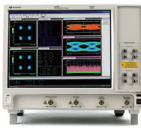
# Keysight Optical Modulation Analyzer Selection Table

[www.keysight.com/find/oma](http://www.keysight.com/find/oma)

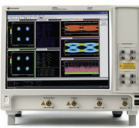
Performance Characteristic	M8292A	N4392A-300/320	N4391A (Z33   Z64)
			
Max. detectable symbol rate	74 GBd	46 GBd	66 GBd   125 GBd
Sample rate	83 GSa/s – 92 GSa/s	63 GSa/s	80 GSa/s   160 GSa/s
Max. record length per channel	512 kSa	16 kSa	Up to 2 GSa
ADC Resolution	8 bit	8 bit	8 bit
Analog Bandwidth (3 dB)	37 GHz	23 GHz	33 GHz   63 GHz
Operating Frequency Range	1 MHz – 40 GHz	50 kHz – 30 GHz	DC – 33 GHz   DC – 63 GHz
Relative skew after correction	< ±1 ps	< ±1 ps	< ±1 ps
EVM noise floor	< 2.4%	< 2.4%	< 1.8%
Sensitivity	- 20 dBm	- 22 dBm	- 20 dBm
Weight	20 kg (44 lbs)	13 kg (29 lbs)	48 kg (106 lbs)   96 kg (212 lbs)
Software platform	VSA/OMA 5.x		

Performance Characteristic	M8296A	N4392A-310	Infiniium Z Series
			
Signal input	Differential	Differential	Single ended
Number of channels	4	4	4   2
Sample rate	83 GSa/s – 92 GSa/s	63 GSa/s	80 GSa/s   160 GSa/s
Max. record length per channel	512 kSa <sup>1</sup>	16 kSa	Up to 2 GSa
ADC resolution	8 bit	8 bit	8 bit
Analog bandwidth (3 dB)	37 GHz	23 GHz	33 GHz   63 GHz
Operating Frequency Range <sup>2</sup>	50 kHz – 42 GHz	50 kHz – 31 GHz	DC – 33 GHz   DC – 63 GHz
Skew betw. different input ch	< ± 250 fs	< ± 2 ps	
RMS noise floor	.6 mV <sub>rms</sub> at 300 mV <sub>FS</sub> 9.5 mV <sub>rms</sub> at 800 mV <sub>FS</sub>		3.3 mV <sub>rms</sub> at 400 mV <sub>FS</sub> 6.4 mV <sub>rms</sub> at 800 mV <sub>FS</sub>
Weight	14 kg (31 lbs)	13 kg (29 lbs)	32 kg (71 lbs)
Software platform	VSA/OMA 5.x		



Keysight N7004A Optical-to-electrical Converter

- DC to 33 GHz typical (-3 dBe, electrical)
- Single-mode and multimode inputs
- 50/125  $\mu\text{m}$ , 750 nm -1650 nm (covers main wavelengths: 850 nm, 1310 nm, and 1550 nm)
- Designed for reference receiver testing of industry optical standards or characterizing raw response of an optical transmitter
- Optical measurement features built into the Infiniium baseline software version 05.70 or higher
- Compatible with Infiniium V-Series, 90000 X-Series, Z-Series and discontinued 90000 Q-Series real-time oscilloscopes

### Fully integrated optical measurements offered with Infiniium baseline software

The Keysight N7004A optical-to-electrical converter is a high-sensitivity photodetector module designed for direct optical-to-electrical conversion of optical telecom or data com signals into an Infiniium real-time oscilloscope with AutoProbe II interface.

The N7004A is the first fully-integrated optical-to-electrical converter solution for Infiniium real-time oscilloscopes. A full suite of optical measurement software is built into the Infiniium baseline software v 05.70 and is offered at no additional cost. The N7004A comes in a compact form factor that is plugged directly into the AutoProbe II probe interface of the Infiniium oscilloscope.

### 33 GHz O/E covering up to 28 Gbps optical input

The adapter provides from DC to 33 GHz of electrical bandwidth. When used with an Infiniium V-Series or Z-Series 33 GHz oscilloscope, the N7004A allows users to view optical streams at speeds up to 28 Gbps, making this the ideal solution for characterizing or troubleshooting high-speed optical signals in the system level testing. The N7004A with an Infiniium real-time oscilloscope is the ideal solution for users who want to see the unfiltered response of optical transmissions as well. Each N7004A adapter contains its unique S-parameter correction filter, and this frequency response data is used to flatten the frequency response for more accurate measurement.

### Designed for reference receiver testing of industry standard optical measurements or characterizing raw response measurement of an optical transmitter

The input is a 50  $\mu\text{m}$ /125  $\mu\text{m}$  fiber that can be used with 9  $\mu\text{m}$  single-mode fiber or 50  $\mu\text{m}$  multimode fiber at wavelengths from 750 to 1650 nm and has a FC/PC adaptor. The reference receiver measurement is made with a built-in 4th order Bessel Thomson software filter that allows the waveform to be viewed similarly to what an optical receiver in an actual communication system would display. The 4th order Bessel Thomson filter bandwidth is limited to 2/3 of the Brickwall bandwidth of the oscilloscope. For a 33 GHz oscilloscope with the Bessel Thomson filter on, this yields a 22 GHz Bessel Thomson filter, which covers 28 Gbps x 0.75 = 21 GHz.

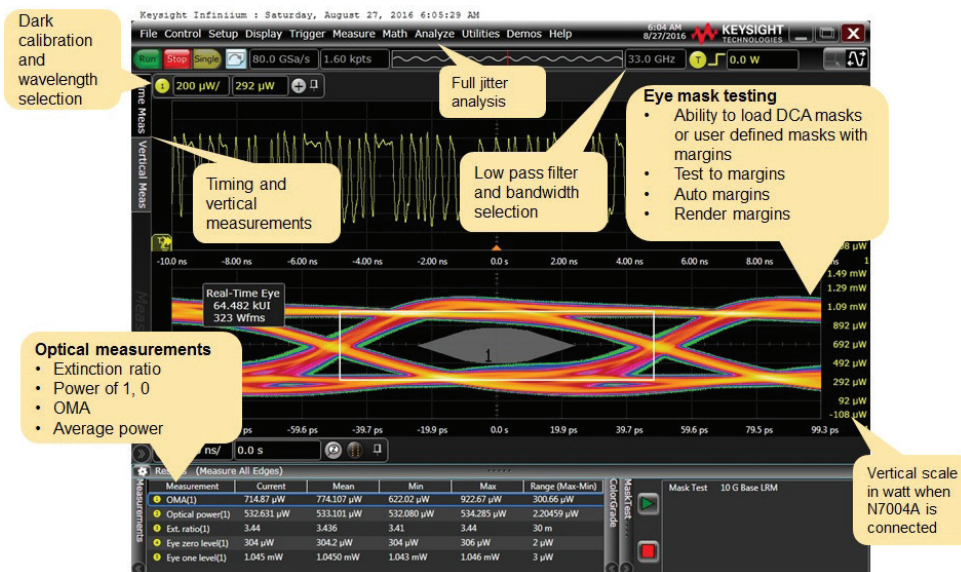

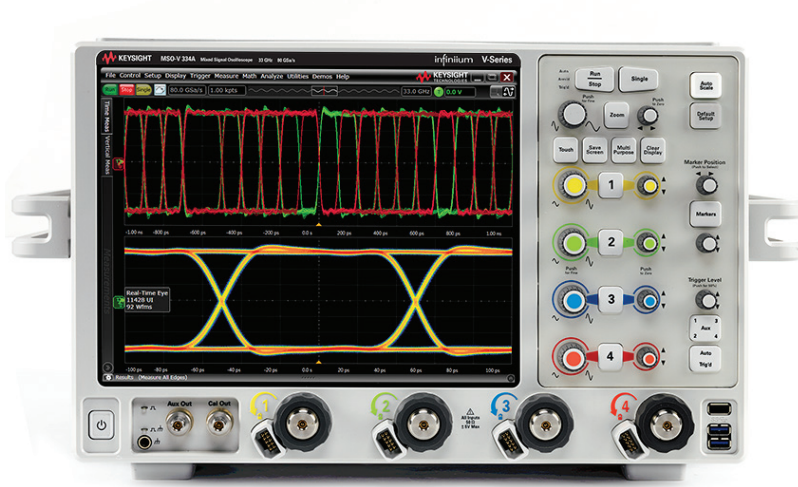

Infiniium V-Series' low-noise front end and the revolutionary voltage termination adapter provide the industry's best signal integrity.

### Groundbreaking oscilloscope technology

The Keysight Infiniium V-Series oscilloscopes incorporate innovative technology designed to deliver superior measurements. Whether you are testing multiple high-speed serial lanes or a passive parallel bus, the new 12.5 Gb/s, industry's longest 160-bit hardware serial trigger and world's fastest 20 GSa/s digital channels will provide timely validation and debug. Our oscilloscope's low-noise front end technology, advanced InfiniiMax III/III+ Series probes and revolutionary voltage termination adapter provide up to 33 GHz performance with the industry's best signal integrity. Together with the broadest software solution coverage, the V-Series helps you achieve clarity faster in your design characterization to ensure your product ships on time.

### Fastest analysis and enhanced usability

We put the groundbreaking oscilloscope technology in an innovate industrial design frame with a standard 500 GB removable solid state drive and high-powered motherboard for fastest analysis, capacitive 12.1" display for multi-touch usability and USB 3.0 ports for fast data offload speed. Coupled with the next-generation Infiniium user interface, the V-Series makes displaying, analyzing and sharing information much easier. It is the first user interface to take advantage of multiple displays and touch screens. It features up to 8 waveform windows with up to 16 grids in each of them, allowing 128 simultaneous viewing spaces.

DSO models	DSA models	MSO models	Analog bandwidth		Sample rate	
4 analog channels	4 analog channels	4 analog ch + 16 digital ch	2 channels	4 channels	2 channels	4 channels
DSOV334A	DSAV334A	MSOV334A	33 GHz	16 GHz	80 GSa/s	40 GSa/s
DSOV254A	DSAV254A	MSOV254A	25 GHz	16 GHz	80 GSa/s	40 GSa/s
DSOV204A	DSAV204A	MSOV204A	20 GHz	16 GHz	80 GSa/s	40 GSa/s
DSOV164A	DSAV164A	MSOV164A	16 GHz	16 GHz	80 GSa/s	40 GSa/s
DSOV134A	DSAV134A	MSOV134A	13 GHz	13 GHz	80 GSa/s	40 GSa/s
DSOV084A	DSAV084A	MSOV084A	8 GHz	8 GHz	80 GSa/s	40 GSa/s





### Three amplifiers for different applications

- Direct DAC – optimized for I/Q signal generation with best SFDR & HD
  - SFDR up to -80 dBc (typ.),  
f<sub>out</sub> = 100 MHz, measured  
DC to 1 GHz
  - Amplitude ~ 350 mVpp .. 700 mVpp, offset -20 to +20 mV
  - Differential output
- DC amplifier 1 – optimized for serial data /time domain applications
  - Amplitude 500 mVpp to 1.0 Vpp; output voltage window:  
-1.0 to +3.3 V
  - Trise/fall, 20% to 80% < 60 ps
  - Differential output
- AC amplifier 1 – optimized to generate direct IF/RF signals
  - 50 MHz to 5 GHz bandwidth
  - Single ended, AC coupled output
  - Amplitude: 200 mVpp to 2.0 Vpp

### M8190A at a glance

- Precision AWG with two DAC settings
  - 14-bit vertical resolution up to 8 GSa/s sampling rate
  - 12-bit vertical resolution up to 12 GSa/s sampling rate
- Variable sample rate from 125 MSa/s to 8/12 GSa/s
- Spurious-free-dynamic range (SFDR) up to 80 dBc typical
- Harmonic distortion (HD) up to -72 dBc typ.
- Up to 2 Gsa arbitrary waveform memory per channel with advanced sequencing
- Analog bandwidth 5 GHz per channel or IQ bandwidth 10 GHz per module
- 3-levels sequencing capabilities
- Digital up-conversion
- Turn-key bundled configuration including chassis and connectivity
- Form-factor: 2 U AXIe module, controlled via external PC or AXIe system controller
- Supported software Keysight Benchlink Waveform Editor, MATLAB, LABVIEW, Keysight Signal Studio (pulse builder and multitone <sup>2</sup>), Keysight SystemVue, Keysight wideband waveform center

### The M8190A Arbitrary Waveform Generator works with all leading software platforms



## High Spectral Efficiency with the Keysight M8190A Arbitrary Waveform Generator

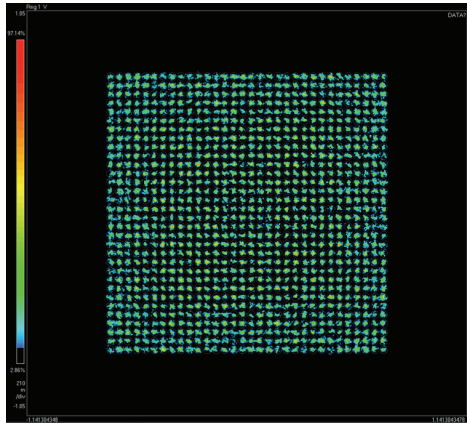

Optical 1024 QAM: 10 bits/Symbol in at 3 GSymbols/sec generated with the high precision M8190A AWG

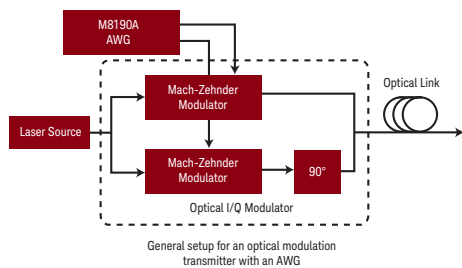

General setup for an optical modulation transmitter with an AWG

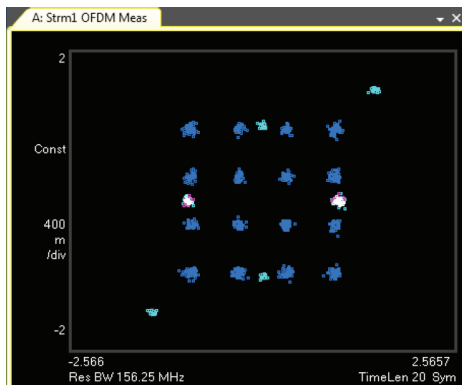

10 Gb/s OFDM Signal with 64 subcarriers generated with the high precision M8190A AWG

The never-ending demand for more data and for higher-speed data can be addressed either due to higher sampling rate/bandwidth or with higher modulation. High order modulations allow cramming more information into the same channel bandwidth but require a very precise and clean signal. With an optical 1024QAM modulation for example it is possible to generate 60 Gbit/s signal, the source is the M8190A a 14 bit arbitrary waveform generator. The signal quality results in up to 20 bit/s/Hz spectral efficiency in dual polarization coherent optical transmission.

Reaching higher spectral efficiency with higher order modulation schemes is one way to serve the broadband hunger by staying with the same infrastructure. Another method would be using a new technology of coding namely CO-OFDM. It stands for Coherent Optical – Orthogonal Frequency Division Multiplexing. This technology is already used for many years in the wireless communication domain and now enters the optical communication world. The main idea behind OFDM is using a numerous orthogonal subcarriers to encode and transmit the data. Each carrier is then complex modulated itself. Either a simple QPSK scheme can be used or higher-order QAM modulations.

Optical OFDM is particularly advantageous in PON networks. With it the bandwidth can be adjusted dynamically by client plus OFDM makes use of cost effective electronic devices instead of costly optical devices in the communication link.





M8195A in a 2-slot AXIe chassis

### M8195A at a Glance

The M8195A is an arbitrary waveform generator with a combination of high sample rate, high bandwidth and high channel density

- Sample rate up to 65 GSa/s (on up to 4 channels)
- Analog bandwidth: 20 GHz
- 8 bits vertical resolution
- Up to 16 GSa of waveform memory per AXIe module
- 1, 2 or 4 differential channels per 1-slot high AXIe module (number of channels is software upgradeable)
- Multi-module synchronization up to 16 channels per 5-slot AXIe chassis
- Advanced 3-level sequencing with external dynamic control
- Load new waveforms on-the-fly without interrupting the playback of the previous one ("memory ping-pong")
- Amplitude up to 1 Vpp(se) (2 Vpp(diff.))
- Trise/fall 20%/80% < 18 ps (typ)
- Ultra low intrinsic jitter
- Built-in frequency and phase response calibration for clean output signals
- 16-tap FIR filter in hardware for frequency response compensation
- Precise trigger
- Up to 2 markers with 1 sample resolution

### Key Applications

As devices and interfaces become faster and more complex, the M8195A AWG gives you the versatility to create the signals you need for digital applications, optical and electrical communication, advanced research, wideband radar and satcom.

- Coherent optical - a single M8195A module can generate 2 independent I/Q baseband signals (dual polarization = 4 channels) at up to 32 Gbaud and beyond
- Multi-level / Multi-channel digital signals - generate NRZ, PAM4, PAM8, DMT, etc. signals at up to 32 Gbaud. Embed/De-embed channels, add Jitter, ISI, noise and other distortions.
- Physics, chemistry and electronics research - generate any mathematically defined arbitrary waveforms, ultra-short yet precise pulses and extremely wideband chirps
- Wideband RF/ $\mu$ W - generate extremely wideband RF signals with an instantaneous bandwidth of DC to 20 GHz for aerospace/defense/communication applications

Go where you have never been able to test before: In speed, in bandwidth and in channel density – explore your possibilities.

The M8195A Arbitrary Waveform Generator works with all leading software platforms

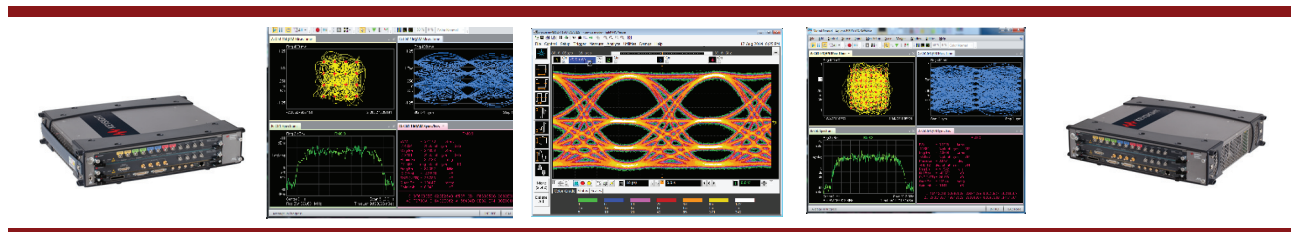

## Coherent optical applications

The M8195A supports leading edge research for 100 Gb/s, 400 Gb/s and 1 Tb/s optical transmission systems that require a very wideband electrical stimulus with a variety of complex modulation formats from QPSK to nQAM to OFDM at symbol rates up to 32 Gbaud and beyond.

In order to drive dual-polarization systems, the M8195A has 4 independent, yet precisely synchronized analog output channels in a single module. Since all 4 channels are generated by the same instrument without any external circuitry, precise synchronization below pico-second-range can be achieved and maintained.

The M8195A uses digital pre-distortion techniques for frequency- and phase response compensation of the AWG output and any external circuits is required in order to achieve a clean signal at the device under test.

Distortions generated by cables, amplifiers, etc. can also be compensated by embedding / de-embedding the S-parameters of the respective circuits or by performing an "in-situ" calibration using the Keysight Vector Signal Analysis software.

The M8195A is suited very well to address those challenging requirements.

With up to 4 channels per 1-slot AXIe module, each running at up to 65 GSa/s with 20 GHz of analog bandwidth in combination with advanced frequency response calibration techniques, it can generate clean as well as purposely distorted signals.

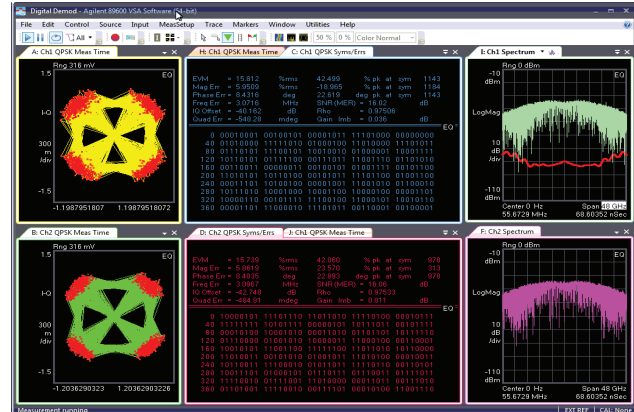

QPSK Signal with added phase noise; emulating a 2 MHz laser line width

## An optical modulation generator tool

The Optical Modulation Generator Tool let you generate complex modulated signals as well as sinusoidal signals for calibration and verification purposes. This dedicated graphical user interface allows to setup dual-polarization I/Q modulations at up to 32 Gbaud and beyond.

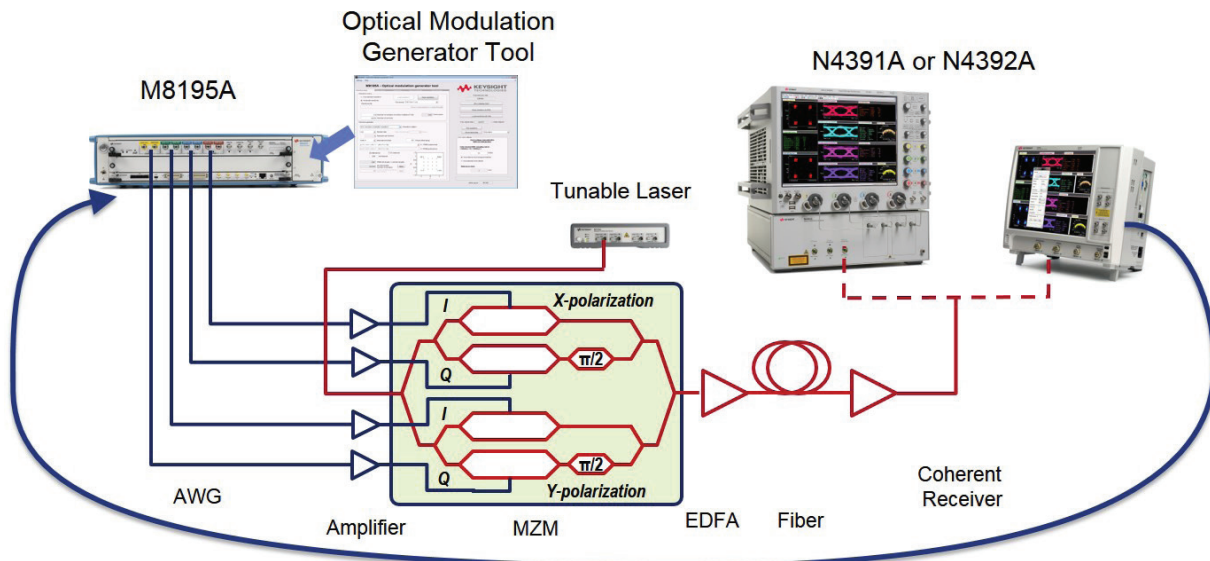

[www.keysight.com/find/m8196a](http://www.keysight.com/find/m8196a)



M8196A in a 2-slot AXIe chassis

### M8196A at a Glance

- The Keysight Technologies, Inc. M8196A arbitrary waveform generator (AWG) has the highest sample rate and the widest bandwidth in its class with up to four synchronized channels operating simultaneously on one module.
- Sample rate up to 92 GSa/s (on up to 4 ch simultaneously)
- Analog bandwidth: 32 GHz (typical)
- 8 bits vertical resolution
- 512 kSa of waveform memory per channel
- 1, 2, or 4 differential channels per 1-slot AXIe module (number of channels is software upgradeable)
- Amplitude up to 1 Vpp(se) (2 Vpp(diff.)), voltage window -1.0 to +2.5 V
- Trise/fall (20%/80%) < 9 ps (typical)
- Ultra-low intrinsic jitter
- Built-in frequency and phase response calibration for clean output signals

### Coherent Optical Applications

200 G, 400 G and 1 Terabit applications demand a new class of generators that provide high speed, precision and flexibility at the same time.

The M8196A is the ideal solution to test different optical systems from discrete components like optical power amplifiers to more complex dual polarization systems like optical modulators or optical receivers.

With up to 4 channels per 1-slot AXIe module, each running at up to 92 GSa/s with 32 GHz of analog bandwidth, it allows dual polarization testing in a small form factor and the generation of complex signals with multiple modulation schemes (PAM-4, PAM-8, QPSK, nQAM) up to an outstanding speed of 64 Gbaud and beyond.

Compensation for distortions generated e. g. by cables and amplifiers can be realized by embedding/de-embedding the S-parameters of the respective circuits or by performing an in-situ calibration using the Keysight Technologies vector signal analysis software.

Combined with the 81195A optical modulation generator software, the M8196A makes it easy to generate optical impairments (e.g. PMD) for stressing the optical receiver over multiple test scenarios.

### Multi-Level/Multi-Channel Digital Signals

The M8196A is also ideally suited to address multi-level/multi-channel interfaces using any standard or custom data format, for example high-speed backplane connections using PAM-4 or PAM-8 format, as well as technologies in the mobile application space.

The flexibility of the waveform generation at its highest speeds, combined with excellent intrinsic jitter performance makes the M8196A a truly future-proof instrument.

At data rates of multiple Gb/s, the effect of cables, board traces, and connectors etc. has to be taken into account in order to generate the desired signal at the test point of the device under test. The M8196A incorporates digital pre-distortion techniques for frequency- and phase-response compensation of the AWG output and any external circuit to generate the desired signal at the device under test. Channels can be embedded/de-embedded if the S-parameters of the respective circuits are provided.

In conjunction with the 81195A optical modulation generator software various kinds of distortions can be added to the signal.

With its high channel density the M8196A is well-suited to affordably and precisely stimulate multi-lane high-speed interfaces.

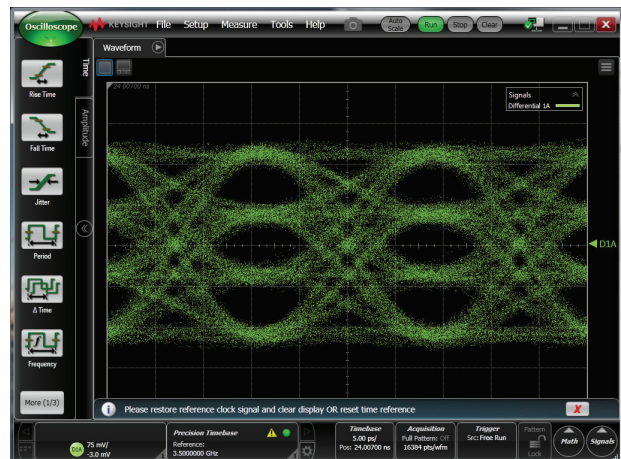

PAM-4 signal at 56 Gbaud

- Data rates up to 8.5/ 16 Gb/s for pattern generator and error detector. Extension to 32 Gb/s possible with M8062A multiplexer
- 1 to 4 16 Gb/s BERT channels in a 5-slot AXIe chassis
- Integrated and calibrated jitter injections: RJ, PJ1, PJ2, SJ, BUJ, clk/2, SSC, sinusoidal interference
- 8- tap de-emphasis (positive and negative) up to 20 dB
- Adjustable and integrated ISI (Intersymbol Interference)
- Interactive link training for PCI Express and USB 3.1
- Built-in clock data recovery and equalization
- Modules and options are upgradeable



J-BERT M8020A high-performance BERT with 4 channels

The high-performance Keysight J-BERT M8020A enables fast, accurate receiver characterization of single- and multi-lane devices running up to 16 or 32 Gb/s.

With today's highest level of integration, the M8020A streamlines your test setup. In addition, automated in situ calibration of signal conditions ensures accurate and repeatable measurements. And, through interactive link training, it can behave like your DUT's link partner. All in all, the J-BERT M8020A will accelerate insight into your design.

### Target applications

R&D and test engineers who characterize, verify compliance of chips, devices, boards and systems with serial I/O ports up to 16 Gb/s and 32 Gb/s. The M8020A can be used to test popular serial bus standards, such as: PCI Express®, USB, MIPI M-PHY, SATA/SAS, DisplayPort, SD UHS-II, Fibre Channel, front-side and memory buses, backplanes, repeaters, active optical cables, Thunderbolt, 10 GbE, 100GbE (optical and electrical), SFP+, CFP2/4 transceivers, CEI.

### Specifications

For operating range 32 Gb/s: see M8062A

For operation up to 16 Gb/s: M8041A and M8151A

### Pattern

- PRBS:  $2^n-1$ ,  $n = 7, 10, 11, 15, 23, 23p, 31$
- Memory: 2 Gbit per channel
- Sequencer: 3 counted loop levels, 1 infinite loop
- Interactive link training for PCIe and USB 3.1
- 10G-KR TX equalization

### Pattern generator

- Operating range: 150 MHz to 8.5 GHz (option G08 or C08), 150 MHz to 16.2 GHz (option G16 or C16). For extension to 32.0 Gb/s: use M8062A in addition
- Data outputs: 1 or 4 for 16 Gb/s (option 0G2 for second channel per M8041/51A module)
- Output amplitude: 50 mV to 1.2 Vpp (single ended)
- Transition time: 12 ps typical (20-80%)
- De-emphasis: 8 taps positive/ negative (option 0G4)
- Intrinsic jitter: 8 ps pp typical
- Connectors: 3.5 mm (f)
- Supplementary outputs: trigger out, clock out, control out, system out

### Jitter tolerance test

- Calibrated jitter sources: multi-UI low-frequency jitter up to 5 MHz, high-frequency jitter up to 1 UI @ 500 MHz (RJ, PJ1, PJ2, BUJ, sRJ),  $\text{clk}/2 \pm 20$  ps
- SSC:  $\pm 5000$  ppm
- ISI: adjustable loss up to 25 dB @ 16 GHz. Additionally eight ISI traces (see M8048A)
- Interference: built-in common-mode up to 400 mV and differential-mode up to 30% of output amplitude
- Automated jitter tolerance test

### Analyzer

- Data inputs: 1 to 4 (option 0A2 for second channel per M8041/51A module)
- Clock recovery: built in, adj. loop bandwidth up to 20 MHz
- Sensitivity: 50 mV
- CTLE: yes
- Connectors: 3.5 mm (f)

### Ordering

J-BERT in 5 -slot AXIe chassis w/ emb. controller	M8020A-BU1
J-BERT in 5 -slot AXIe chassis	M8020A-BU2
16 Gb/s BERT 2 ch with clock, 3-slot AXIe module	M8041A <sup>1</sup>
16 Gb/s BERT 2 ch, 2-slot AXIe module	M8051A
32 Gb/s Front-end for J-BERT	M8062A
System software for M8000 Series	M8070A

1. available options for M8041A: 8.5/16Gb/s, generator-only, 2nd channel generator/analyzer, de-emphasis, jitter sources, interference sources, reference clock multiplier, SER/FER analysis, link training, CTLE, ISI



- Expands data rate of J-BERT M8020A up to 32.4 Gb/s
- Fully unique integrated capabilities for higher-data-rate testing
  - Integrated adjustable inter symbol interference (ISI) helps engineers quickly test over a large range of channel loss without moving cables
  - Integrated analyzer equalization ensures accurate BER measurements by opening eyes in the looped-back channel
- Integrated 8-tap de-emphasis allows engineers to emulate transmitter operation and de-embed test setups
- Improved efficiency and accuracy for 100G and beyond testing
- Interactive TxEQ training for 25GBASE-KR and 100GBASE-KR4
- Control from J-BERT M8020A high-performance BERT



The M8062A multiplexer in a 32 Gb/s BERT setup with J-BERT M8020A

The M8062A 32 Gb/s module expands the J-BERT M8020A high-performance BERT with versatile generator and analyzer functionality at data rates up to 32.4 Gb/s. The newly integrated capabilities streamline testing for R&D and test engineers who need to characterize devices and systems for next-generation data-center and long-haul-communication applications. Fully integrated capabilities like inter symbol interference generation, clock data recovery and analyzer equalization greatly improve device characterization and compliance testing and significantly simplifies test setups. The M8062A is a 2-slot AXIe module that can be controlled via USB through the integrated user interface of the J-BERT M8020A or through remote programming commands to allow test automation.

### Target applications

R&D and test engineers who characterize, verify compliance of chips, devices, boards and systems with serial I/O ports up to 32 Gb/s. Typical receiver test applications include:

- Optical transceivers such as 100GBASE-LR4, -SR4 and -ER4, 32G Fibre Channel
- SERDES and chip-to-chip interfaces, such as OIF CEI
- Backplanes, cables, such as 100GBASE-KR4, -CR4
- SAS-4 receiver testing
- Thunderbolt 20G and active optical cables

### Get accurate results based on M8062A's excellent output performance

The eye quality of the pattern generator output is critical when characterizing many pass through devices such as TOSAs. The low intrinsic random jitter assures that you will be measuring the true performance of the device under test itself. Fast transition times preserve the eye opening at the highest data rates, maintaining margins for repeatable BER measurements.

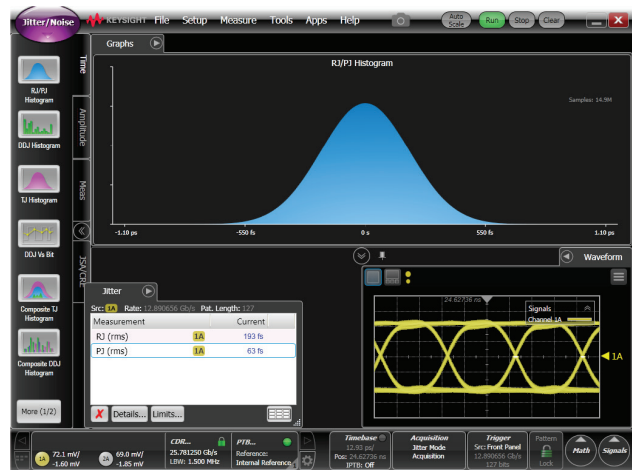

Intrinsic RJ < 200 fs

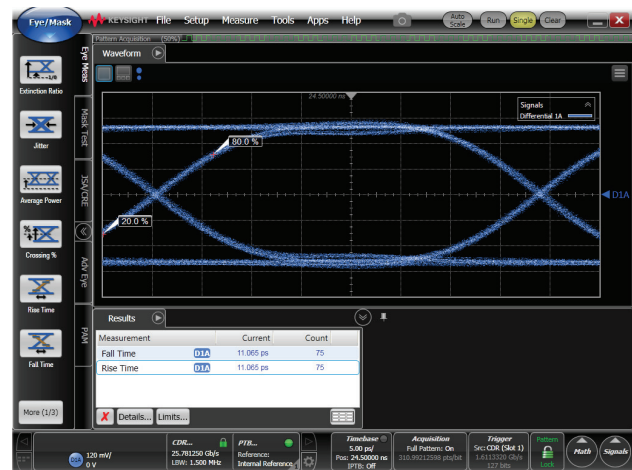

Output eye showing rise time < 12 ps

## M8040A 64 Gbaud High-Performance BERT

[www.keysight.com/find/m8040a](http://www.keysight.com/find/m8040a)

- Data rates from 2 to 32 and 64 Gbaud for pattern generator and analyzer
- PAM-4 and NRZ selectable from user interface
- Built-in de-emphasis with 4 taps
- Integrated and calibrated jitter injection: RJ, PJ1, PJ2, SJ, BUJ, and clk/2 jitter
- Two pattern generator channels per module to emulate aggressor lane
- True PAM-4 error detection in real-time for low BER levels
- Built-in equalization



M8040A 64 Gbaud High-performance BERT

### Key specifications for M8040A

Pattern generator module M8045A with remote head M8057A	
Operating range	2.025 to 32.4 Gbaud (M8045A-G32), 2.025 to 58 Gbaud (opt. G64) with over-programming up to 64.8 Gbaud
Data formats	NRZ and PAM-4 (option -OP3 and -OP6)
Data outputs	1 or 2 per module
Output amplitude	50 mV to 0.9 Vpp (single ended) for symbol rates < 32.4 Gbaud, 50 mV to 0.6 Vpp (single ended) for symbol rates < 58Gbaud
Transition time	9 ps typical for symbol rates > 32.4 GBd, 11 ps typical (20-80%) for < 32.4 GBd
De-emphasis	4 taps positive/ negative (option -OG4)
Intrinsic jitter	7 mUI rms typical for symbol rates between 22 and 32.4 Gbaud
Connectors	1.85 mm (f)
Supplementary outputs	trigger out, clock out, control out, system out
Pattern	
PRBS	2 <sup>n</sup> -1, n = 7,10, 11, 15, 23, 23p, 31, 33, 35, 39, 45, 49, 51
QPRBS	QPRBS13-CEI, QPRBS31-CEI, QPRBS13, PRBS13Q, PRBS31Q, SSPRQ
Memory	2 Gbit per channel
Sequencer	3 counted loop levels, 1 infinite loop
Jitter tolerance test	
Calibrated jitter sources	multi-UI low-frequency jitter up to 10 MHz, high-frequency jitter up to 1 UI @ 500 MHz (RJ, PJ1,PJ2, BUJ, sRJ), clk/2 (M8045A-OG3)
SSC	±5000 ppm
Level interference	adjustable RI and SI injection via M8195/6A and external couplers
Analyzer module M8046A	
Operating range	5.0 Gbaud to 32 Gbaud for M8046A-A32, 5.0 Gbaud to 64.8 Gbaud for M8046A-A64
Data inputs	1 per module
Data formats	NRZ and PAM-4 (option -OP3)
Sensitivity	70 mV per eye
Clock recovery	with N1076A and N1077A for NRZ and PAM-4

### Master your 400G design

The Keysight M8040A is a highly integrated BERT for physical layer characterization and compliance testing. With support for PAM-4 and NRZ signals and data rates up to 64 Gbaud (corresponds to 128 Gbit/s) it covers all flavors of 200 and 400 GbE standards.

The M8040A BERT offers true error analysis and provides repeatable and accurate results optimizing the performance margins of your 400GbE devices.

### Target applications

The M8040A is designed for R&D and test engineers who characterize chips, devices, transceiver modules and sub-components, boards and systems with serial I/O ports operating with symbol rates up to 32 Gbaud and 64 Gbaud in the data center and communications industries. The M8040A can be used for receiver (input) testing for many popular interconnect standards, such as:

- IEEE 802.3bs 400 and 200 Gigabit Ethernet
- IEEE 802.3bj, IEEE802.3cd
- OIF CEI - 56G (NRZ and PAM-4 versions)
- 64G/112G Fibre Channel, Infiniband-HDR
- Proprietary interfaces for chip-to-chip, chip-to-module, backplanes, repeaters, and active optical cables, operating up to 64 Gbaud.



### Fast, compact, and affordable BER testing

Testing 16x Fibre Channel (16GFC) transceivers, Infiniband FDR, Infiniband EDR, 100 G Ethernet etc, requires equipment capable of operating up to at least 25 Gb/s, with accurate characterization to strict tolerances. Until now, these systems have been extremely expensive. This often results in multiple designers needing to share the one serial BERT in the lab, delaying their characterization and development schedule.

The Keysight Technologies N4960A serial BERT 32 and 17 Gb/s is an affordable alternative for R&D working at data rates up to 32 Gb/s.

The solution is compact, allowing it to be easily transported throughout the lab and manufacturing. But with its low price, a fraction of competing stressed BERTs, you can afford to put one on each bench.



16 x Fibre Channel (16 GFC) transceiver testing

### Compact architecture

The N4960A serial BERT controller is a platform that forms the basis of the stressed serial BERT. The N4960A serial BERT controller adds the precision timing and control required for the remote pattern generator and error detector heads.

The concept of remote heads, first introduced in the N4965A multi-channel BERT, puts the pattern generation and error detection near the device under test, eliminating long cables which degrade the signal. This is especially important at higher data rates.



N4980A JTOL measurement window

### Affordability without compromise

The N4951A/B pattern generator and N4952A error detector remote heads are available in two data rate ranges covering either 4 to 17 Gb/s or 5 to 32 Gb/s with no gaps or missing data rates. They generate and test full rate patterns directly without the need for external multiplexers and delay matching often used in other modular BERT systems.

The signal fidelity in the eye is outstanding, owing to the use of custom-designed and built output amplifiers. Output parameters of amplitude, offset, and termination voltage are user settable.

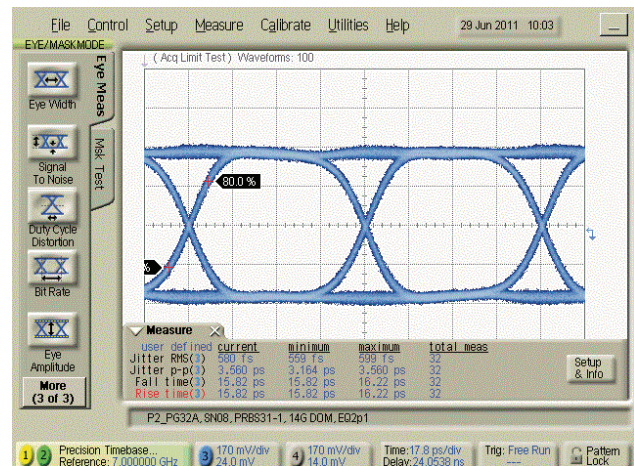

Typical eye at 14 Gb/s

### Accurate, repeatable jitter tolerance

The N4960A serial BERT controller contains an accurately calibrated sinusoidal jitter source capable of high deviation at low frequencies, and lower deviation at frequencies up through 200 MHz. A second sinusoidal jitter source, plus random jitter source and spread spectrum clocking can be added with option -CJ1.

### Integrated analysis software

Support for both models of the N4960A is included in the N4980A multi-instrument BERT software. The software provides an intuitive user interface. It also provides single or multi-channel BER measurement capability with an unlimited number of channels. Setup is so easy that you'll be testing in seconds.

The optional JTOL measurement package in the N4980A multi-instrument BERT software (Signal Integrity Studio) performs all the set-up and control for single or multi-lane JTOL, and with an intuitive "point and click" template editor.

**N4960A Controller Specifications**

Standalone clock source and/or Serial BERT controller

Clock output configuration:

Jitter (stressed), Delay, and Divided outputs available. Clock generator Jitter and Delay outputs are shared with Pattern Generator (PG) and Error Detector (ED) heads respectively. The PG/ED data rate is double the frequency of the clock outputs.

1.5 to 16 GHz (1.5 to 8.5 GHz when N4951A-P17, N4951B-H17/D17 or N4952A-E17 is attached)

Jitter (stressed), Delay, and Divided

Differential

300 mV to 1.7 V pp, single ended

0 to  $\pm 1,000$  UI

$\div 1, 2, 3, \dots, 99,999,999$  integer divider

Jitter clock injection (with no pattern generator heads attached)

Sinusoidal SJ1, SJ2 1 – 200 MHz, up to 1UI

Random RJ Up to 25 mUI

Periodic PJ 1 to 17 MHz, up to 100 UI (to 62.5 kHz)

SJ2, RJ requires Option -CJ1. The amplitude of any stress appearing on the front panel jitter clock output will be 1/2 of the value appearing in the N4951A/B pattern generator head. Changing stress amplitudes on the front panel jitter clock output will also change the level appearing on the pattern generator output

Spread spectrum clock (Option -CJ1) 1 Hz to 50 kHz, 0 to 1.0 %, Triangle, down spread, center spread, or up spread.

Keysight N4951B



Keysight N4952A



<b>Pattern generator head specifications</b>	
Data rate range	4 to 17 Gb/s (Options P17/H17/D17) 5 to 32 Gb/s (Options P32/H32/D32)
Pattern selection	
– PRBS	$2^n - 1$ , $n = 7, 9, 10, 11, 15, 23, 29, 31, 33, 35, 39, 41, 45, 47, 49, 51$ K28.3, K28.5, K28.7, CJPAT, CJTPAT, CRPAT, JSPAT, JTSPAT
– Clock	$\div 2, \div 4, \div 8, \dots, \div 64$
– User	1 bit to 8 Mb programmable using N4980A Multi-instrument Software
Data output configuration	Differential. May be operated single end with unused output terminated into 50 $\Omega$ AC Coupled with internal bias tee
Data output amplitude	Adjustable up to 1V pp single ended (option P17/32), 1.5V (option D17/D32), 3V (option H17/H32)
Data output amplitude	16 ps typical (Options P17/P32/ D17/ D32), 12 ps typical (Options H17/H32)
De-emphasis	Option D17/D32 has integrated 5-tap de-emphasis
Jitter injection	
– Sinusoidal SJ1, SJ2	1 to 150 MHz, up to 0.8 UI
– Random RJ	Up to 24 mUI
– Periodic PJ	1 to 17 MHz, up to 100UI (to 62.5 kHz) SJ2, RJ requires N4960A controller with Option –CJ1
<b>Error detector head specifications</b>	
Data rate range	4 to 17 Gb/s (Option E17) 5 to 32 Gb/s (Option E32)
Pattern selection	
– PRBS	$2^n - 1$ , $n = 7, 9, 10, 11, 15, 23, 29, 31, 33, 35, 39, 41, 45, 47, 49, 51$ K28.3, K28.5, K28.7, CJPAT, CJTPAT, CRPAT, JSPAT, JTSPAT
– Clock	$\div 2, \div 4, \div 8, \dots, \div 64$
– User	1 bit to 8 Mb programmable using N4980A Multi-instrument software
Data output configuration	Differential. May be operated single end with unused output terminated into 50 $\Omega$ .AC coupled with internal bias tee
Data input range	100 mV to 1 V (p-p) single ended
Data delay range	$\pm 2000$ UI
Measurements	Instantaneous and accumulated BER, Error count, Errored 1's and 0's, Data loss, Sync loss. Multi-channel BER, bathtub scan, jitter tolerance testing (with N4980A software)
<b>N4960A controller options</b>	
N4960A-CJO	Standard jitter injection (single tone sinusoidal)
N4960A-CJ1	Expanded jitter injection (two tone sinusoidal, random and SSC)

## Remote head options:

- N4951A-P17 pattern generator 17 Gb/s
- N4951A-P32 pattern generator 32 Gb/s
- N4951B-H17 pattern generator high amplitude 17 Gb/s
- N4951B-H32 pattern generator high amplitude 32 Gb/s
- N4951B-D17 pattern generator with 5-tap de-emphasis 17 Gb/s
- N4951B-D32 pattern generator with 5-tap de-emphasis 32 Gb/s
- N4952A-E17 error detector 17 Gb/s
- N4952A-E32 error detector 32 Gb/s



The Keysight N4980A multi-instrument BERT software provides the ability to control multiple instruments through a rich Windows-based graphical user interface (GUI). Bit error rate measurements are simple to set up with the intuitive control screens. The software is ideal for setting up and performing parallel BER measurements and jitter tolerance testing (N4980A-JTS) in multi-lane and SERDES devices. You can also create your own patterns using the powerful editing tools built into the pattern editor to meet your unique requirements.

#### Key features & Specifications

- Software is Windows-based controlling equipment through USB or GPIB
- Simple and fast setup
- Full instrument remote control
- Test single and multi-lane BER with active aggressor signals
- Monitor instantaneous BER over time or measure BER over a specific period
- Fast and efficient parallel jitter tolerance testing (N4980A-JTS)
- View BER-measured BERT scan (often called bathtub curve, a horizontal slice through eye)
- Intuitive pattern editor
- De-emphasis tap weight calculator for easy calculation of required tap settings and programming to supported de-emphasis pattern generators

#### Applications

- Serial data receiver characterization
- Parallel BER measurements
- N4980A-JTS for jitter tolerance testing
- Optical transceiver/transponder characterization

The base software is available free of charge (registration required for download). The N4980A-JTS jitter tolerance measurement package is an option enabled by a software key.





The N5291A enables PLTS 2018 to achieve 6-picosecond equivalent system risetime measurements providing better than 400-micron spatial resolution.

### Breakthrough Manufacturing Test Capability

Breakthrough spatial resolution of 6 picoseconds The new Physical Layer Test System (PLTS) 2018 has significant breakthrough capabilities with regards to resolving adjacent impedance discontinuities within high-speed interconnects, such as cables, backplanes, PCBs and connectors. Many signal integrity laboratories around the world have benefited from the power of PLTS in the R&D prototype test phase. PLTS 2018 now supports the new N5291A PNA MM-wave system that provides a single continuous sweep of 900 Hz to 120 GHz in a single box (see Figure 1 below). This new hardware support enables not only excellent low frequency performance for power integrity applications, but also achieves the best-in-class highest stop frequency of 120 GHz which directly translates to a 6-picosecond equivalent system risetime. This 6-picosecond risetime allows adjacent impedance discontinuities of less than 400 microns to be resolved in high-performance BGA (ball grid array) ceramic IC packages. High-speed SERDES chipsets designed for 400G network and data centers can now be fully characterized and optimized for high performance.

### Python interface

Another significant enhancement to PLTS 2018 is the addition of a Python programming interface. Python is a widely used high-level programming language that features a dynamic system that supports multiple programming paradigms, including object-oriented, imperative, functional programming, and procedural styles. While the previous version of PLTS 2017 used the MATLAB programming interface, Python allows for custom processing of data out of and back into PLTS. This new language interface furthers the remote and factory automation applications for high-volume production of backplanes, PCBs, connectors, cables and IC packages. See the PLTS 2018 built-in Help for additional details and programming examples.

### 64-port S-parameter analysis

The last major enhancement to PLTS 2018 is 64-port S-parameter capability. Many sophisticated backplane applications have multiple channels that need extensive crosstalk characterization in order to comply to the new high-speed digital standards. The 64-port S-parameter analysis allows eight differential pairs to be fully scrutinized for near-end and far-end crosstalk in any combination. This allows over 4096 waveforms to be recalled onto a PLTS canvas quickly and easily in multiple domains. There are very few signal integrity tools on the market that have a complete cross talk characterization of hardware and software built into a single analysis system.

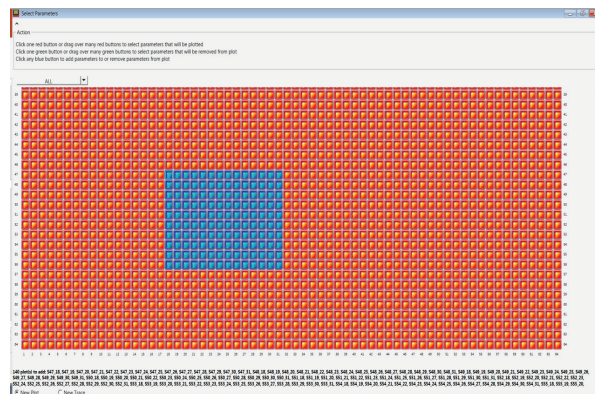

The 64-port S-parameter analysis capability in PLTS 2018 includes Automatic Fixture Removal (AFR), Round Robin, N-port Reference Plane Adjustment, Import, Export and more.

Many other features not mentioned in this document can be found in PLTS 2018. Our design team looks forward to working together with you to overcome any signal integrity problems and help you design the highest quality data transmission channels possible.



### Repeatable Optical Receiver Stress Test for 100GBASE-SR4/LR4/ER4

The telecommunications industry represented by the IEEE decided to address the steadily increasing need for more bandwidth at a lower cost for the intra and inter data centers by combining the spectral efficient PAM-4 modulation with the mature direct modulation/direct detection technology. The shift from NRZ to PAM-4 modulation effectively doubles the line rates, as compared to optical 100 Gigabit ethernet transceivers, while maintaining modulation speed at 26.56125 Gbaud and enabling continued use of some of the existing 100 G components.

Consequently, the compliance test procedures defined for next-generation 400 GBase transceivers are similar to those adopted in IEEE 802.3ba for NRZ-based 100 GBASE transceivers. But there are noticeable differences:

A new TDECQ metric is employed to characterize the quality of a transmitted/received signal instead of the traditional eye mask analysis.

A digital reference equalizer is required to compute various signal metrics during transmitter performance testing or during stress signal calibration for receiver stress testing.

Because of the significant sensitivity penalty resulting from the shift from NRZ to PAM4, the optical transceiver is not expected to operate error-free under the stress conditions defined by the standards or during typical use, while forward error correction (FEC) is typically performed outside the transceiver module.

Therefore, achieving accurate, stable and repeatable stress signal calibration, to ensure reliable transceiver performance test and qualification, has become even more challenging. Optical receiver stress test procedures, defined by the IEEE, are performed using several instruments such as a bit error ratio tester, digital sampling oscilloscope, optical reference transmitter and tunable laser source. The purpose of the test is to generate a stable and repeatable stressed optical signal with specific characteristics, and send it to the receiver under test to measure the resulting bit error ratio.

However, achieving this is not a trivial task as the combination of different stress factors (inter symbol interference, jitter, sinusoidal interferences, Gaussian noise, optical power level) gives rise to complex dependencies on the target metrics.

Keysight's optical receiver BERT compliance apps are designed to address the test needs of 100, 200 and 400GBASE standards and multi-source agreements. For instance, the N4917BSCA BERT compliance app enables a complete test solution from instrument configuration and control to automated stressed signal calibration and system performance test, according to IEEE 802.3bs specifications (clauses 121 & 122) for following standards:

- 200 GBASE-FR4/-LR4/-DR4 IEEE 802.3bs
- 400 GBASE-FR8/-LR8 IEEE 802.3bs

Automation of the stress signal calibration and conformance tests results in considerable time savings. In addition, the N4917BSCA optical receiver stress test solution provides:

- Automated calibration of the optical stressed eye according to IEEE 802.3bs clause 121 and 122
- Adjustable target values for outer extinction ratio (OER), stress eye closure (SECQ), optical modulation amplitude (OMA) enabling user-defined stress signal calibration
- Repeatable and stable calibration of optical stressed PAM-4 eye
- Automated stress receiver sensitivity and jitter tolerance tests
- Unified instrument control and setup
- Customized device testing and reporting via DUT control and scripting interface

Keysight's optical receiver stress test solutions are using the same hardware platform based on the M8040A high-performance BERT. To leverage existing equipment, different hardware configurations are supported and can be used for other kinds of device compliance test such as for optical transmitters and chip-to-module interfaces.



## Automated Stress Signal Calibration

The optical receiver BERT compliance apps calibrate the following stressed receiver conformance test signal metrics

- VECP, SEC (for multimode), J2, J4, J9 and OMA for NRZ signals
- SECQ, OER, OMA for PAM4 signals

The target values can be adjusted for instance to support a new MSA. The calibration procedure then performs specific steps to create an impaired signal using the specified stress components and measuring the stress signal calibration metrics. Below an overview of the 200 and 400GBASE calibration process:

- The pattern generator output amplitude is adjusted so that the clean eye signal (i.e., sinusoidal jitter, sinusoidal interferer and Gaussian noise turned off) has approximately the minimum extinction ratio as specified in the standard.
- The initial SECQ due to inter-symbol-interference, mostly resulting from the frequency response of the E/O converter is adjusted using the de-emphasis capability of the pattern generator.
- After turning on the sinusoidal jitter (SJ), sinusoidal interferer (SI) and Gaussian noise (GN), the software changes iteratively the amplitudes of the stress components until all stressed signal metrics are met.
- The results of the calibration process are displayed and the parameters of the stressed receiver test signal are stored in a calibration file to be recalled for the same setup

The stressed receiver conformance test signal as defined in IEEE 802.3bs allows certain degrees of freedom to meet the specified target metrics: For example, the frequencies of sinusoidal jitter and sinusoidal amplitude interferer are not exactly specified by the standard but can be set in the given range. Also, the ratio between sinusoidal interferer and Gaussian noise is not specified in the IEEE 802.3bs standard but may be specified by the user.

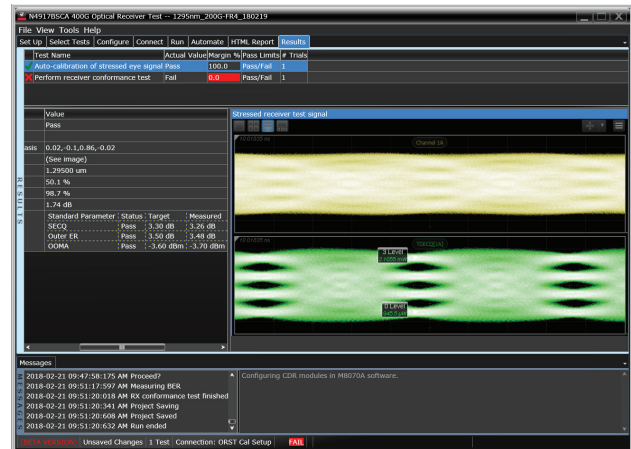

Calibration results for 200G-FR4

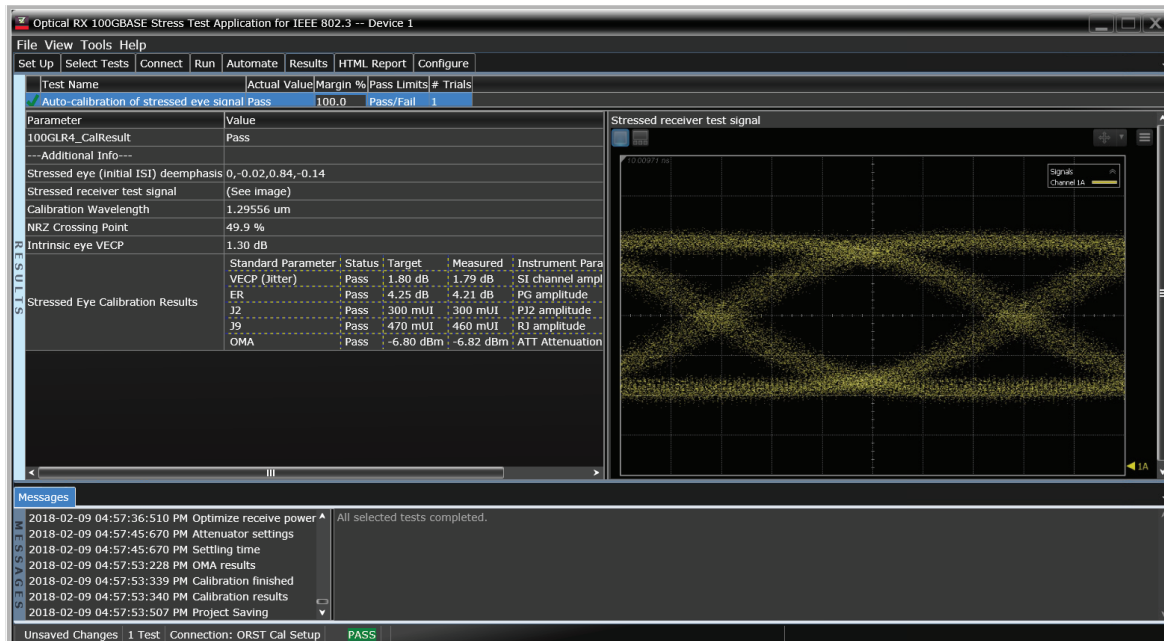

Calibration results for 100G-LR4

## Automated Compliance and Performance Tests

The automated compliance and performance tests use nearly the same setup as used for the stressed receiver signal calibration. The difference is that the optical fiber from the attenuator output is connected to the optical input of the receiver/lane under test instead of the input of the DCA. The optical receiver is stressed with the calibrated compliance test signal on the lane under test and the received bit error rate (BER) is measured and compared against the target value under various conditions. Note that all the other optical lanes are supposed to be activated to serve as optical cross-talk source. A possible realization of such requirement is illustrated in figure below.

Different approaches to recover the BER are supported:

- The BER can be retrieved from the transceiver internal error counter – if any. In this case the communication between the device under test and the N4917BSCA solution software is realized using the DCI interface of the M8070 software.
- If no internal error counter is available on the transceiver, an error detector should be employed to measure the BER of the lane under test. The clock signal use for the error detector should be extracted from the recovered signal.

Following tests are fully automatized:

- Rx Compliance Test: measures the Rx BER compliance at the stressed receiver sensitivity (OuterOMA) as defined in IEEE 802.3bs
- Jitter Compliance Test: measures the Rx BER compliance at different jitter frequencies with maximum jitter amplitude as defined in IEEE 802.3bs Table 121-12
- Rx Sensitivity Measurement: measures the Rx BER versus stressed receiver sensitivity (OuterOMA)
- Jitter Performance Measurement: measures the Rx BER versus jitter frequency and amplitude Standard

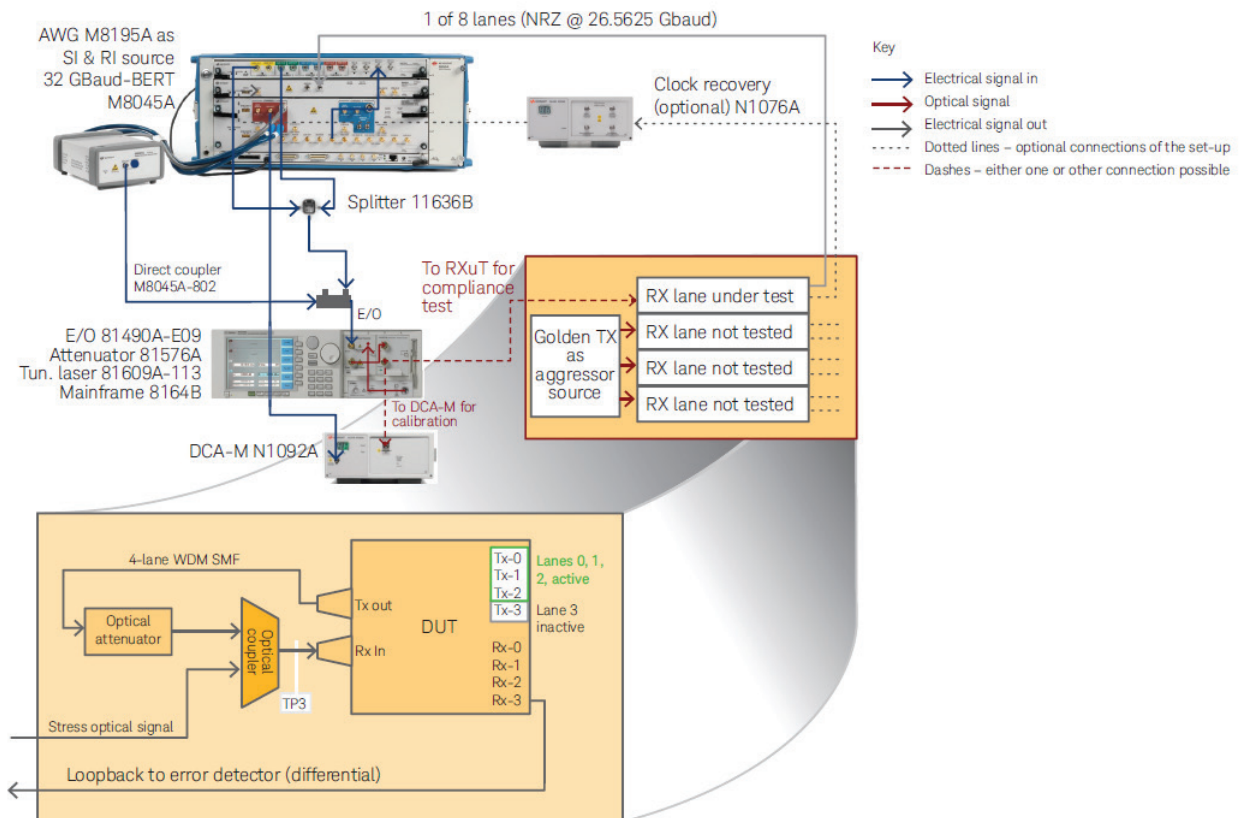

Optical receiver stress test setup for 200 GBASE-LR4/-FR4



Keysight's 81490A Reference Transmitter is designed to offer excellent eye quality for NRZ and PAM4 signals at baud-rates up to 32Gbaud. It comes in Multimode and Single-Mode flavors and includes internal lasers at 850nm (MM) or 1310&1550nm (SM). External optical input for usage with tunable laser sources is available on request. The integration in the LMS mainframe offers a variety of advanced features such as automated bias-point and power control, remote control via SCPI language and much more. The LMS mainframe platform also offers seamless integration into various performance and compliance test solutions like the N4917BSCA optical receiver stress test.

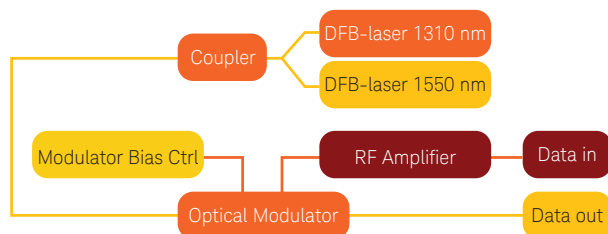

81490A-135 1310 nm/1550 nm reference transmitter

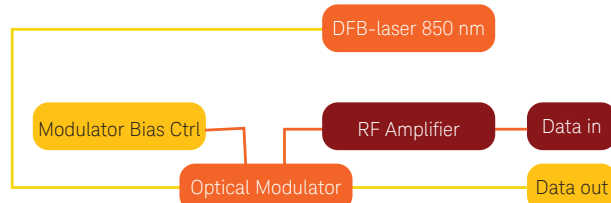

81490A-E03 850 nm reference transmitter

The separation of the signal source and the modulator is the only way to offer a zero-chirp modulation. This is essential for a clean and repeatable eye-diagram when modulating with an appropriate clean external source to fulfill the requirements of the IEEE standard. Another advantage of this design compared to directly modulated transmitters is the wide extinction ratio range that can only be achieved with this design.

### Benefits

- Repeatable and reproducible measurements permit lower production test margins and improved specifications of the characterized devices
- Reliable measurements ensure comparability of the test results
- Support for full compliance to IEEE 802.3 stressed eye test in combination with the Optical Receiver Stress Test solutions
- Wide extinction range offers highest test range coverage to ensure best quality of the tested devices under all target operating conditions
- Rapid test reconfiguration with dual-wavelength to switch between 1310 nm and 1550 nm by remote control or manually without exchanging a module
- Scalability with integration into industry-standard Keysight LMS platform extends your optical workbench capabilities

### Application

- Reference transmitter for stressed eye compliance test according to IEEE 802.3 and 10 G Fiber Channel
- Creation of arbitrary optical modulation signals in combination with waveform generators
- General transmission system test with special pulse patterns in combination with a pattern generator

### Specifications

- Operational baud rate: 622 Mb/s to 32 Gbaud (on request)
- Electro-optical modulation bandwidth: 10 MHz to 33 GHz typ. Electro-optical conversion ratio: > 5 mW/V
- Maximum extinction ratio: > 10 dB
- Jitter (peak - peak): < 12 ps (Option 135)
- Relative intensity noise (RIN): RIN < -136 dB/Hz
- Transmitter wavelength: 850 ± 10 nm (Option E03), 1310 ± 10 nm, 1550 ± 10 nm (Option 135)
- Average optical output power: P > 0.0 dBm (Multimode), P > 5.0 dBm (Single-mode)
- Rise and fall time, <15ps typ.



#### N1076B electrical CR, N1077A and N1078A optical/electrical CR solution for BER and waveform analysis

- Continuous, un-banded tuning from 125 MBd to 56/64 GBd
- Ultra low residual jitter: < 100 femtoseconds rms
- Golden PLL operation with a tunable loop bandwidth from 30 kHz to 20 MHz for configurable standard compliant test
- PLL BW/jitter transfer and phase noise/jitter spectrum analysis

Both bit-error-ratio-testers (BERTs) and DCA's require a clock signal to synchronize the measurement system to the incoming data stream. When the necessary synchronous clock/trigger is not available, a common solution is to derive a clock from the data being measured. The N1076B/N1077A standalone clock recovery instruments provide ideal performance for waveform analysis and BER test.

They can derive a clock from NRZ and PAM4 signals with rates as low as 125 MBd, as high as 56/64 GBd and any rate between, providing the ultimate in flexibility and value.

With jitter as low as 100 fs rms, the residual jitter of the output clock is virtually negligible, allowing accurate measurements of very low levels of signal jitter and high margin in jitter tolerance/receiver tests.

#### Electrical and optical clock recovery solutions up to 56/64 GBd

N1076B Electrical Clock Recovery provides:

- 125 MBd to 16/32/64 GBd (continuous)
- Support for both NRZ and PAM4 signals
- Ultra-low residual random jitter < 100 fs RMS
- Jitter spectrum analysis (JSA) capability
- Golden phase-locked loop (PLL) for compliant operation

N1077A Optical/Electrical Clock Recovery provides:

- 50 MBd to 32 GBd (continuous) for both SM and MM applications
- Support for both NRZ and PAM4 signals
- Ultra-low residual random jitter < 100 fs RMS
- Jitter spectrum analysis (JSA) capability
- Golden phase-locked loop (PLL) for compliant operation
- Integrated O/E and clock recovery design
- Optical splitter: Integrated (Option SMS) or External - user supplied (Option SXT)

N1078A Optical/Electrical Clock Recovery provides:

- 125 MBd to 16/32/64 GBd for SM applications
- Support for both NRZ and PAM4 signals
- Built-in variable equalizer helps to recover a clock from data signals having "closed eyes"
- Optical splitter: integrated 50:50 splitter (Option S50) or External - user supplied (Option SXT)

#### PLL and jitter spectrum analysis

Use 86100DU-400 software to make fast, accurate and repeatable measurements of phase-locked loop (PLL) bandwidth/jitter transfer. With a precision jitter source, the 86108B, N1076B, N1077A or N1078A can be configured as a jitter receiver to create a PLL stimulus-response test system.



## Get 86100 DCA accuracy with a test solution designed for manufacturing

The Keysight Technologies, Inc. 86100 digital communication analyzer (DCA) family is recognized as the industry standard for verifying optical transmitter compliance to communications standards. For years engineers have trusted the DCA to provide accurate and easy measurement of digital communication waveforms. The Keysight N109X DCA-M family has built on that legacy by using the high-performance elements of both the 86100 oscilloscope mainframe acquisition system and the optical and electrical channel hardware of the 861XX plug-in modules. The N1090A supports 1 to 10 Gb/s measurements, while the N1092 and N1094 are for use from 20.6 to 28 Gb/s. (NRZ and PAM4) and 53 Gb/s (TDECQ on PAM4) (Data rate ranges of the N1092 can be extended using Options PLK and IRC.)

## Designed specifically for high-volume manufacturing test applications

Designed specifically for high-volume manufacturing test applications, the DCA-M provides the measurement accuracy of the 86100, without the extra cost associated with an R&D test solution. Be confident that your test results will never be questioned when performed with an N109X because end users of your transceivers and components are likely to use similar accurate, high-quality test systems to verify component performance.

## Integrated Instruments built in a small form factor

Unlike the 86100, which uses modules to create a waveform analysis system, the N109X are completely integrated instruments built in a small form factor. Low-noise, high-sensitivity calibrated reference receivers – compliant to industry standard tolerances – are available for both multimode and single-mode signals at wavelengths from 750 to 1630 nm. N1090A noise is as low as 1  $\mu$ W, while N1092 noise is as low as 4  $\mu$ W, creating a measurement system with very high dynamic range. The sensitivity of the N1092 is significantly better than the comparable 86100 system making it an excellent solution for PAM-4 waveform analysis. Electrical channels are available with 20 GHz (N1090A), 30 GHz, and 50 GHz bandwidths (N1092/4).

## Based on the modern FlexDCA user interface

The N109X user interface and operating system is identical to the modern FlexDCA interface of the 86100D. A user-provided PC running N1010A FlexDCA software controls the N109X over a simple USB 2.0 or 3.0 connection.

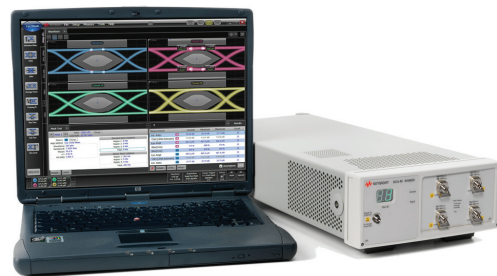



## Controlling the N109X

There are three ways to control the N109X system

- A PC directly connected to the N109X with a USB cable
- An 86100D mainframe connected to the N109X with a USB cable. (The 86100D can then be controlled via GPIB or LAN)
- For an automated test system environment, the simplest and preferred method to control the N109X is to connect the primary test system PC to a low-cost modern PC via LAN. The FlexDCA interface resides on the second PC. The second PC is then connected to the N109X via USB. This eliminates most issues of compatibility between an existing test system PC and the N109X hardware and can greatly simplify converting an 86100D system to an N109X system

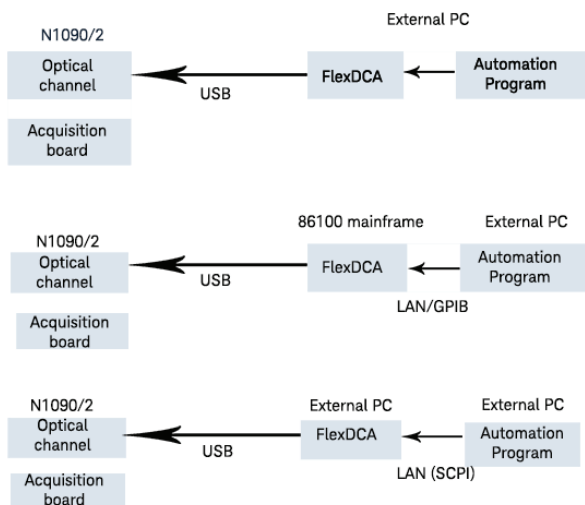

### System setup

The following guidelines indicate the fundamental requirements for PC's connected to the N109X and running the FlexDCA interface:

For a single channel setup (N1090A or N1092A)

- Intel I3 processor or better
- 4 GB memory
- Windows 7 (32 or 64 bit)

For a parallel test setup (multiple instruments or multiple channels)

- Intel I5 or better
- 8 GB memory
- Windows 7 (64 bit)

### SCPI over LAN

The communication API between your system controller and the PC is SCPI over LAN, either VXI-11 or HiSlip. If NI-VISA or IO Libraries are used to communicate with GPIB instruments, the switch to SCPI/LAN is very simple. It is important to note that there is no need to do any USB programming. This is all handled by the FlexDCA interface.

### The FlexDCA interface is free

The FlexDCA interface is free and can be downloaded at [www.keysight.com/find/flexdca\\_download](http://www.keysight.com/find/flexdca_download). Remote programs previously developed using the 86100 FlexDCA interface can be leveraged directly to control an automated N109X system. Use FlexDCA SCPI programming tools to simplify conversion of legacy 86100-based automation to FlexDCA compatible code. Measurement results are generally 50 percent faster with the new N1090A, and up to 300 percent faster with the N1092/4 due to significantly faster sampling rates.

### Reduce cost of ownership

Similar to the 86100, a reference clock, synchronous with the signal being measured, is required to trigger the N109X. The clock input range for the N1090A is 500 MHz to 12 GHz, and the N1092 and N1094 are 500 MHz to 28.5 GHz. Timebase calibration, previously performed at service centers, can now be performed by users, reducing cost of ownership and instrument down time.

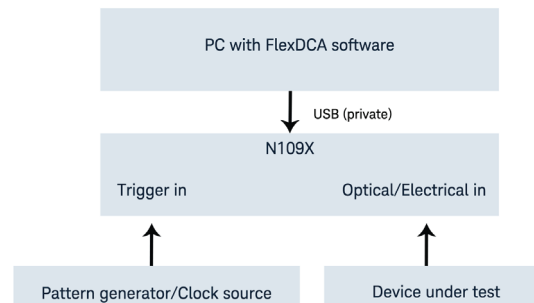

Fundamental measurements required to perform transmitter compliance tests such as eye-masks, extinction ratio, and other eye diagram parameters, are standard features of the N109X with N1010A system.

### Cost reduction

To reduce cost, the pattern lock feature of the 86100 is not available in the N1090A, but is optionally available with the N1092/4 Option PLK. Features that require pattern lock include Options 200 (advanced jitter analysis), 201 (advanced waveform analysis), 300 (advanced amplitude analysis/RIN), Option IRC (extends the operating range of the optical channels  $\pm 50\%$  and creates reference receivers at arbitrary data rates between 10 and 42 Gb/s), and SIM (Infinisim waveform transformation software). Measurement features that require pattern lock will not operate when used with the N1090A system. Basic oscilloscope mode measurements of pulses rather than eye diagrams are limited to patterns less than 2 ns in duration with the N1090A.



## N1090A Configurations

Choose from the following reference receiver options to best meet your measurement needs. Select one option. Options cannot be combined. However if test needs change, the N1090A can be returned to a Keysight service center to convert from any of the five reference receiver options to one of the other four options listed. Unfiltered mode is not available in any option.



Option	Description
Option 140	1.244/1.25/1.229 Gb/s
Option 160	2.458/2.488/2.5 Gb/s
Option 180	3.072/3.125 Gb/s
Option 200	8.5/9.95/10.3/10.5/10.66/10.71/11.1/11.3 Gb/s
Option 204	8.5/9.95/10.3/10.5 Gb/s

A 20 GHz electrical channel is also available:

Option	Description
Option EEC	Add 20 GHz electrical channel

## N1092/4 Configurations



All optical channels include optical reference receivers at 25.78, 26.56, 27.95, and 28.05 Gb/s. Using the FlexDCA user interface, simultaneous measurements of multiple channels can be performed in parallel without any degradation in speed or accuracy.

Model number	Description
N1092A	One optical channel
N1092B	Two optical channels
N1092C	One optical, two electrical channels
N1092D	Four optical channels
N1092E	Two optical, two electrical channels
N1094A	Two electrical channels
N1094B	Four electrical channels

## N1092/4 Configurations

The N1092C and N1092E electrical channels have 50 GHz bandwidths that can be reduced by the user to 20, 33 and 40 GHz. Note that operation of Options 200, 201, 300, 401, 500, 9FP, and SIM can be achieved by having the appropriate licenses installed on the N1092, the computer controlling the N1092, or an 86100 mainframe used to control the N1092.

Option	Description
Option 168	25.78 Gb/s TDEC filter (100GBASE-SR4) (not available with the N1094)
Option 206	20.6 Gb/s ref receiver (not available with the N1094)
Option FS1	Increase sampling rate from 100 to 250 kSa/s
Option LOJ	Reduce residual jitter from 400 to < 200 fs
Option PLK	Add pattern lock capability
Option IRC	Extend optical channel bandwidth to 45 GHz and allow creation of reference receiver filters at any data rate from 8 to 42 Gb/s (not available with the N1094)
Option 200	Advanced jitter analysis. Provides extensive and accurate jitter decomposition, which is increasingly important as data rates increase and margins reduce. Quickly customize your view of many parameters and take advantage of advanced features such as jitter spectrum analysis
Option 201	Advanced waveform analysis. Its powerful features allow you to generate much deeper waveform files, integrate MATLAB analysis, and use the built-in linear feed-forward equalizer
Option 300	Advanced amplitude/noise analysis. Extends jitter mode capabilities into the amplitude domain and allows you to see the decomposition of the amplitude into several factors. Option 300 also reports relative intensity noise (RIN) and Q-factor
Option 401	Advanced eye analysis. For device testing with long patterns and obtaining BER-contour mask testing, Option 401 integrates with the classic or FlexDCA interfaces to decompose the jitter and amplitude interference measurements into the key parameters. When using the embedded capability within FlexDCA or the included automation application, you may characterize jitter on simultaneous multiple lanes and obtain concise and visual results
Option 500	Productivity package (Rapid eye, TDEC). Enables rapid eye acquisition, providing two significant benefits. First, unlike conventional sampling and data display, when an eye mask test is performed, every acquired sample will be compared to the mask, as the central eye is composed of all acquired samples. Effective throughput is improved at least 60 percent. Second, incomplete eye diagram displays that can occur when triggering at sub-rates are eliminated. Option 500 also includes the TDEC analysis required for 100GBASE-SR4 test
Option 9FP	PAM-N analysis. Eye width, eye height, eye skew, level amplitude, level noise, level skew, and linearity measurements
Option SIM	Infinisim Waveform Transformation software
Option 030	Configure electrical channels with a 30 GHz bandwidth (not available with the N1092)
Option 050	Configure electrical channels with a 50 GHz bandwidth (N1092C/E have standard 50 GHz bandwidths for the electrical channels)

The 86100 series digital communications analyzer is the industry standard for characterizing high-speed transmitter waveforms. Integrated, calibrated optical reference receivers coupled with built-in automated compliance software are the key to accurate measurements.

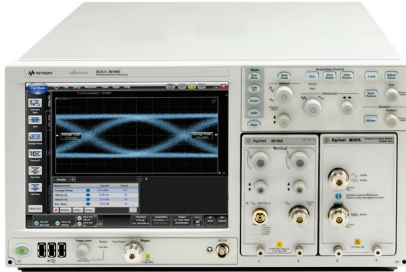

The 86100D DCA-X has been engineered for unmatched accuracy, insight, and ease-of-use. In addition to providing industry leading signal integrity measurements, the DCA-X provides:

#### Accurate characterization of optical waveforms

The 86100D is the ideal tool for viewing optical transceiver signals. A variety of plug-in modules are available with built-in optical receivers allowing the highest accuracy in waveform analysis. Industry standard reference receivers provide the correct frequency response to validate compliance to SONET/SDH, Ethernet, Fibre Channel and other specifications. Select from several plug-in modules to get the configuration that best matches your transceiver applications. Built-in test applications provide the following measurements:

- Automatic testing to industry standard eye masks
- Accurate measurement of eye-diagram parameters including extinction ratio, eye-height and width, crossing percentage
- Fast throughput and simultaneous multiple channel testing for extremely low cost-of-test
- Simultaneous parallel mask test for up to 16 channels with up to 64 parametric measurements

#### Powerful new INSIGHT

- Integrated de-embedding/embedding capability (using 86100D-SIM InfiniiSim-DCA license)
- Advanced signal processing such as filtering, FFT, differentiate and integrate functions
- New measurement capability, including Data Dependent Pulse Width Shrinkage (DDPWS), uncorrelated jitter (UJ), J2, J9 and more

#### Improved USABILITY

- Dual user interface (FlexDCA, DCA-J "classic" user)
- Display up to 64 measurements simultaneously
- ONE button setups

#### Improved PRODUCTIVITY

- Built-in waveform simulator with random/periodic jitter and noise generator
- Live or offline signal analysis (using N1010A FlexDCA remote access software)

#### NEXT GENERATION platform

- Supports up to 16 channels for testing high density ASIC/FPGA testing and parallel designs. New option 86100D-PTB integrates the precision timebase within the mainframe allowing ultra-low jitter for up to 16 channels
- Vertical gain and offset controls that can be assigned to all channels and functions
- User-defined multi-purpose button
- 3X faster CPU than DCA-J
- 100% backwards compatibility with all DCA modules

#### Improves margins and helps to differentiate products for a wide range of applications such as:

- Transceiver design and manufacturing
- ASIC / FPGA / IC design and characterization
- Signal integrity measurements on Serial bus designs
- Cables, Printed Circuit Boards (PCB)

#### Precision measurements on high-speed signals at the touch of one button!

- Scope mode yields the most accurate waveform measurements
- Eye/Mask mode provides fast and accurate compliance testing of transceivers
- TDR/TDT mode for precision impedance measurements with S-parameter capability. TDR edge speed faster than 10 ps with > 50 GHz BW
- Jitter and amplitude mode for comprehensive analysis of signal characteristics

#### Powerful analysis features provide greater insight

- Integrated de-embedding, embedding, and equalization capability
- Jitter spectrum and phase locked loop (PLL) analysis
- Jitter analysis on long patterns such as PRBS31

#### Lowest cost of test

- Modular platform supports up to 16 parallel channels
- Optimized algorithms designed for manufacturing test
- Modular – buy only what you need today knowing you can upgrade later
- Protect your investment – the 86100D is 100% compatible with all DCA modules

## Scope mode

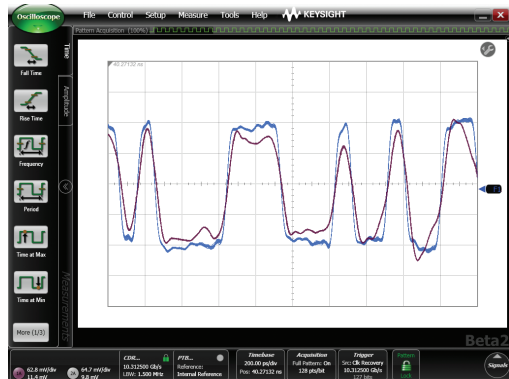

High-fidelity waveform characterization (Purple: raw trace, Blue: de-embedded waveform)

## Eye/Mask mode

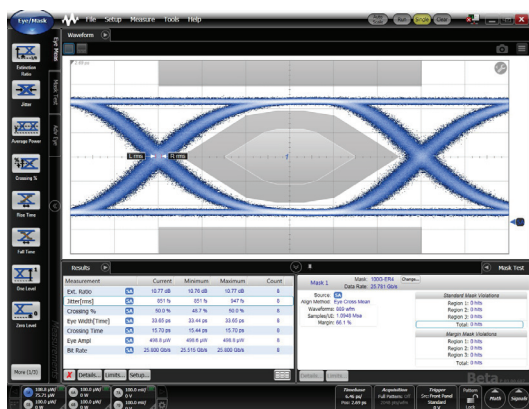

Fast transmitter characterization using eye-diagram analysis and automated mask margin measurements

## Precision measurements, more margin, and more insight

The 86100D DCA-X oscilloscope combines high analog bandwidth, low jitter, and low noise performance to accurately characterize optical and electrical designs from 50 Mb/s to over 80 Gb/s. The mainframe provides the foundation for powerful insight and measurement capability, such as de-embedding of cables and fixtures, that improve margins and allow engineers to see the true performance of their designs.

## Modular

The modular system means that the instrument can grow to meet your needs, when you need it. There's no need to purchase capability that you don't need now. The DCA-X supports a wide range of modules for testing optical and electrical designs. Select modules to get the specific bandwidth, filtering, and sensitivity you need. The DCA-X supports all modules in the DCA family and is 100% backwards compatible with the 86100C mainframe.

## Jitter mode

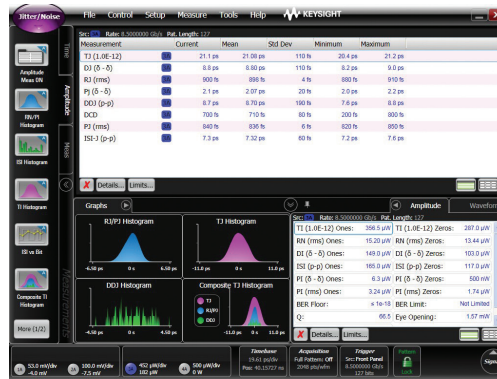

Precision jitter, amplitude, and frequency analysis capability

## TDR/TDT mode

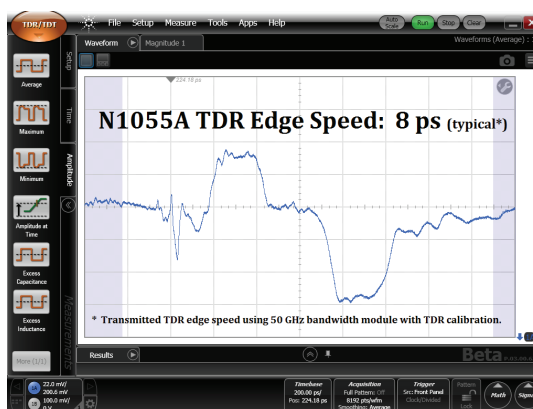

Accurate time domain reflectometry/transmission and S-parameter measurements

## Software

The DCA-X provides powerful analysis capability that is enabled through licensed software options. Examples include 86100D-200 for fast and accurate jitter analysis, and 86100D-SIM for de-embedding and/or embedding of fixtures and cables.

The 86100D DCA-X features two user interfaces for optimum ease-of-use. It includes the classic DCA interface for complete backwards compatibility with earlier DCA mainframes. It also includes the new FlexDCA interface that provides new measurements and powerful analysis capability in a fully customizable application.

The following measurements are available from the tool bar, as well as the pull down menus. The available measurements depend on the DCA-X operating mode.

## Oscilloscope mode

### Time

Rise Time, Fall Time, Jitter RMS, Jitter p-p, Period, Frequency, + Pulse Width, - Pulse Width, Duty Cycle, Delta Time, [Tmax, Tmin, Tedge—remote commands only].

### Amplitude

Overshoot, Average Power, V amptd, V p-p, V rms, V top, V base, V max, V min, V avg, OMA (Optical Modulation Amplitude).

## Eye/Mask mode

### NRZ eye measurements

Extinction ratio, Jitter RMS, Jitter p-p, Average Power, Crossing Percentage, Rise Time, Fall Time, One Level, Zero Level, Eye Height, Eye Width, Signal to Noise, Duty Cycle Distortion, Bit Rate, Eye Amplitude.

### RZ eye measurements

Extinction Ratio, Jitter RMS, Jitter p-p, Average Power, Rise Time, Fall Time, One Level, Zero Level, Eye Height, Eye Amplitude, Opening Factor, Eye Width, Pulse Width, Signal to Noise, Duty Cycle, Bit Rate, Contrast Ratio.

### Mask test

Open Mask, Start Mask Test, Exit Mask Test, Filter, Mask Test Margins, Mask Margin to a Hit Ratio, Mask Test Scaling, Create NRZ Mask.

### Advanced measurement options

The 86100D's software options allow advanced analysis. Options 200, 201, and 300 require mainframe Option ETR. Option 202 does not require mainframe Option ETR. Option 401 does not require Options ETR and 200 unless a DDPWS measurement is required.

## Option 200 enhanced jitter analysis software

### Measurements

Total Jitter (TJ), Random Jitter (RJ), Deterministic Jitter (DJ), Periodic Jitter (PJ), Data Dependent Jitter (DDJ), Duty Cycle Distortion (DCD), Intersymbol Interference (ISI), Sub-Rate Jitter (SRJ), Asynchronous periodic jitter frequencies, Subrate jitter components.

### FlexDCA adds the following measurements:

Data Dependent Pulse Width Shrinkage (DDPWS), Uncorrelated Jitter (UJ), Jn (J2, J4, J5,...J9), Even-Odd Jitter (EOJ, or F/2).

### Data displays

TJ histogram, RJ/PJ histogram, DDJ histogram, Composite histogram, DDJ versus Bit position, Bathtub curve (log or Q scale).

## Option 201 advanced waveform analysis

### Measurements

Deep memory pattern waveform, user-defined measurements through MATLAB interface.

### Data displays

Equalized waveforms using LFE, DFE, and CTLE equalizers.

## Option 202 enhanced impedance and S-parameters

## Option 300 amplitude analysis/RIN/Q-factor (requires Option 200)

### Measurements

Total Interference (TI), Deterministic Interference (Dual-Dirac model, DI), Random Noise (RN), Periodic Interference (PI), and Inter-symbol Interference (ISI), RIN (dBm or dB/Hz), Q-factor.

### Data displays

TI histogram, RN/PI histogram, ISI histogram

## Option 400 PLL and jitter spectrum measurement software

### Jitter spectrum/phase noise measurements

Integrated Jitter: Total Jitter (TJ), Random Jitter (RJ), Deterministic Jitter (DJ); DJ Amplitude/Frequency, Jitter Spectrum Graph, Jitter versus Time Graph, Frequency versus Time Graph, Jitter Histogram, Post Processed Jitter Measurements, Phase Noise Graph dBc/Hz versus frequency.

### Phase Locked Loop (PLL) measurements

PLL bandwidth, PLL Peaking, Data Rate, Jitter Transfer Function (JTF) Graph, Observed Jitter Transfer (OJTF) Graph, JTF Model.

### Option 401 advanced EYE analysis

#### Jitter measurements

Total Jitter (TJ), Random Jitter (RJ), Deterministic Jitter (DJ), J2 Jitter (J2), J9 Jitter (J9), Data Dependent Pulse Width Shrinkage (DDPWS)\*

\* Requires 86100D-200

#### Amplitude measurements

Total Interference (TI), Random Noise (RN), Deterministic Interference (DI), Eye Opening

#### Mask test (using Microsoft (TM) Excel workbook)

Pass/Fail status, hits or hit ratio limits

### Option 500 productivity package

Improve the efficiency of eye-diagram testing by 40% or more

### Option 9FP PAM4 Analysis

#### Eye/Mask Mode Measurements

Eye Width (EW), Eye Height (EH), Linearity, Level, TDECQ, Outer Optical Modulation Amplitude (OMA), Extinction Ratio (ER), Skew, and more.

#### Jitter/Amplitude Mode Measurements (requires Option 200/300)

Eye Width (EW), Eye Height (EH), Level, Skew, full jitter/amplitude decomposition, Symbol Error Rate (SER) floor, Output Jitter (J4u,  $J_{RMS}$ , EOJ), and more.

### Option SIM infiniiSim-DCA

2-port de-embedding and embedding; 4-port de-embedding and embedding; add simulated random jitter and noise

### TDR/TDT mode (requires TDR module)

#### Quick TDR, TDR/TDT setup

Normalize, Response, Rise Time, Fall Time,  $\Delta$  Time, Minimum Impedance, Maximum Impedance, Average Impedance (Single-ended and Mixed-mode S-parameters with Option 202)

### Additional capabilities

#### Standard functions

Standard functions are available through pull down menus and soft keys, and some functions are also accessible through the front panel knobs

#### Markers

Two vertical and two horizontal (user selectable)

#### TDR markers

- Horizontal – Seconds or meter
- Vertical – Volts, ohms or percent reflection
- Propagation – Dielectric constant or velocity

### Limit tests

- Acquisition limits
- Limit test "Run Until" Conditions – Off, # of Waveforms, # of samples
- Report action on completion – Save waveform to memory, save screen image

### Measurement limit test

- Specify number of failures to stop limit test
- When to fail selected measurement – inside limits

### Outside limits, always fail, never fail

- Report action on failure – Save waveform to memory, save screen image, save summary
- Mask limit test
- Specify number of failed mask test samples
- Report action on failure – Save waveform to memory, save screen image, save summary

### Configure measurements

#### Thresholds

- 10%, 50%, 90% or 20%, 50%, 80% or custom

#### Eye boundaries

- Define boundaries for eye measurements
- Define boundaries for alignment

#### Format units for

- Duty cycle distortion – Time or percentage
- Extinction/Contrast ratio – Ratio, decibel or percentage
- Eye height – Amplitude or decibel (dB)
- Eye width – Time or ratio
- Average power – Watts or decibels (dBm)

#### Top base definition

- Automatic or custom

#### $\Delta$ Time definition

- First edge number, edge direction, threshold
- Second edge number, edge direction, threshold

#### Jitter mode

- Units (time or unit interval, watts, volts, or unit amplitude)
- Signal type (data or clock)
- Measure based on edges (all, rising only, falling only)
- Graph layout (single, split, quad)



### Quick measure configuration

When using the classic DCA interface, “Quick Measure” measurements are initiated by pressing the <Multi-Purpose> button on the front panel.

- Four user-selectable measurements for Each Mode, Eye-mask, TDR, etc.
- Default Settings (Eye/Mask mode) Extinction Ratio, Jitter RMS, Average Power, Crossing Percentage
- Default Settings (scope Mode) Rise Time, Fall Time, Period, Vamptd

## Histograms

### Configure

- Histogram scale (1 to 8 divisions)
- Histogram axis (vertical or horizontal)
- Histogram window (adjustable window via marker knob)

### Math measurements – Classic DCA user interface

- Four user-definable functions operator magnify, invert, subtract, versus, min, max
- Source – Channel, function, memory, constant, response

### Signal processing measurements – FlexDCA

- Math – Add, Sub, Multiply, Average, Invert, Max, Min, Median
- Signal Processing – Difference (Differentiate), Summation (Integrate), Interpolation (Linear, Sin(x)/x), Filters: 4th Order Bessel, Butterworth, Gaussian
- Option – IRC allows extended operating range and improved frequency response of optical reference receivers
- Transforms – FFT, versus
- Equalizer (Opt 201) – Linear Feed-forward Equalizer (LFE, up to 64 taps)
- Simulation (Option SIM) – De-embedding, embedding, random jitter, random noise

## Calibrate

### All calibrations

- Module (amplitude), Horizontal (time base)
- Extinction ratio, probe, optical channel

### Front panel calibration output level

- User selectable –2 V to 2 V

### Touch screen configuration/calibration

- Calibration, Disable/enable touch screen

## Additional capabilities

### Waveform autoscaling

Autoscaling provides quick horizontal and vertical scaling of both pulse and eye-diagram (RZ and NRZ) waveforms.

### Gated triggering

Trigger gating port allows easy external control of data acquisition for circulating loop or burst-data experiments. Use TTL compatible signals to control when the instrument does and does not acquire data.

### Easier calibrations

Calibrating your instrument has been simplified by placing all the performance level indicators and calibration procedures in a single high-level location. This provides greater confidence in the measurements made and saves time in maintaining equipment.

### Stimulus response testing using the Keysight N490X BERTs

Error performance analysis represents an essential part of digital transmission test. The Keysight 86100D and N490X BERT have similar user interfaces and together create a powerful test solution. If stimulus only is needed, the 81133A and 81134A pattern generators work seamlessly with the 86100D.

### Transitioning from the Keysight 83480A and 86100A/B/C to the 86100D

While the 86100D has powerful new functionality that its predecessors don't have, it has been designed to maintain compatibility with the Keysight 86100A, 86100B, 86100C and Keysight 83480A digital communications analyzers and Keysight 54750A wide-bandwidth oscilloscope. All modules used in the Keysight 86100A/B/C, 83480A and 54750A can also be used in the 86100D. Since the 86100D includes the classic DCA interface, the remote programming command set for the 86100D designed for the 86100A/B/C will work directly. Some code modifications are required when transitioning from the 83480A and 54750A, but the command set is designed to minimize the level of effort required.

### SCPI programming tools for FlexDCA

To facilitate easier and faster remote code development, the FlexDCA user interface includes several SCPI programming tools. The SCPI recorder, for example, records user interaction (via the scope front panel, mouse, or touchscreen) and reports the equivalent SCPI remote-programming command to the user via a Record/Playback pop-up window.

### IVI-COM capability

Interchangeable Virtual Instruments (IVI) is a group of new instrument device software specifications created by the IVI Foundation to simplify interchangeability, increase application performance, and reduce the cost of test program development and maintenance through design code reuse. The 86100D IVI-COM drivers are available for download from the Keysight website.

### VXII.2 and VXII.3 instrument control

The 86100D DCA-X provides LAN based instrument control.



## 86100D Wide-Bandwidth Oscilloscope Selection Table (Cont.)

[www.keysight.com/find/dcax](http://www.keysight.com/find/dcax)

## 86100 family plug-in module matrix (Continued)

The 86100 has a family of plug-in modules designed for a broad range of precision optical, electrical, and TDR/TDT measurements. The 86100D can accommodate up to 4 modules for a total of 16 measurement channels.

Module	Option	No. of optical channels	No. of electrical channels	TDR/TDT/S-parameters	Probe Power <sup>1</sup>	Electrical bandwidth (GHz)
54754A		0	2	●	●	18
86108A <sup>3,4</sup>		0	2		●	32
86108B <sup>3,4</sup>	LBW	0	2		●	35
	HBW	0	2		●	50
86112A		0	2		●	20
	HBW	0	2		●	30
86118A		0	2			70
N1045A <sup>4</sup>		0	2			60
N1045A <sup>4</sup>		0	4			60
N1046A <sup>4</sup>	71F	0	1			75
N1046A <sup>4</sup>	81F	0	1			85
N1046A <sup>4</sup>	11F	0	1			100
N1046A <sup>4</sup>	72F	0	2			75
N1046A <sup>4</sup>	82F	0	2			85
N1046A <sup>4</sup>	12F	0	2			100
N1046A <sup>4</sup>	74F	0	4			75
N1046A <sup>4</sup>	84F	0	4			85
N1046A <sup>4</sup>	14F	0	4			100
N1055A <sup>4</sup>	32F/32M	0	2	●		35
N1055A <sup>4</sup>	34F/34M	0	4	●		35
N1055A <sup>4</sup>	52F/52M	0	2	●		50
N1055A <sup>4</sup>	54F/54M	0	4	●		50

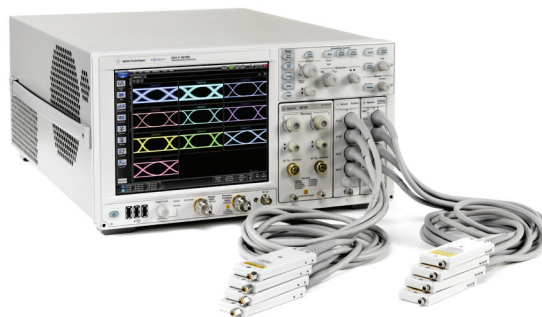

1. Module has receptacle to supply power for external probe.
2. This module is not compatible with the 86100A and 86100B Digital Communication Analyzer (DCA) mainframes. If you would like to upgrade older DCA's contact Keysight Technologies and ask for current trade-in deals.
3. The 86108A/B uses all module slots and includes internal clock recovery and precision timebase capabilities.
4. Requires 86100D mainframe (not compatible with 86100A/B/C).

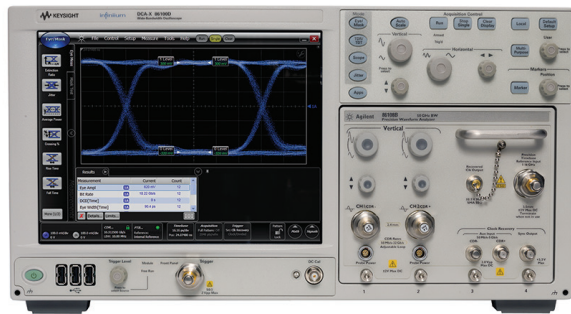

The ultimate in accuracy and ease-of-use for analyzing high-speed electrical NRZ/PAM4 signals

Highest accuracy scope featuring:

- Ultra-low jitter < 50 fs (typ.)
- Wide bandwidth
  - > 35 GHz (Option LBW)
  - > 50 GHz (Option HBW)
- Clock-data delay mitigation ("0 ns" delay)

Easy setup and operation:

- Simple one connection 'triggerless' operation
- Auto setup for serial bus differential signaling including PCI-EXPRESS®, SATA, HDMI, DisplayPort, SFP+, 8 GFC, 10 GbE

PLL characterization/Jitter transfer:

- Flexible operation: Data or clock input/output, 50 Mb/s to 2 Gb/s or 25 MHz to 16 GHz
- Compliant: PCI SIG approved, SONET/SDH

Integrated hardware clock recovery:

- Continuous clock recovery rates:
  - 50 Mb/s to 16 Gb/s (Option 216)
  - 50 Mb/s to 32 Gb/s (Option 232)
- Adjustable loop bandwidth (LBW)/Type-2 transition frequency (Peaking)
  - "Golden PLL" loop bandwidth adjustment 15 KHz to 20 MHz (rate dependent)
  - Peaking 0 to > 2dB (bandwidth dependent)
- Exceeds industry standards for SSC tracking

The Keysight 86108B precision waveform analyzer is a plug-in module used with the 86100C/D DCA Wide-Bandwidth Oscilloscope. An optimum combination ultra-low jitter, low noise, and wide bandwidth makes the 86108B the ideal choice in helping engineers develop and test designs for PCI-EXPRESS®, SATA, SAS, HDMI, DisplayPort, SFP+, Fibre Channel, CEI, Gb Ethernet, and any proprietary rate to 32 Gb/s. The 86108B overcomes conventional test equipment limitations and provides designers with the confidence that the waveform displayed by the oscilloscope is a faithful representation of the true device performance for today's technologies as well as future generations.

New architecture yields precision measurements and easy-to-use operation

The 86108B combines two high-bandwidth channels, an instrumentation-grade clock recovery which features variable loop bandwidth and peaking, and a precision timebase into a single unit.

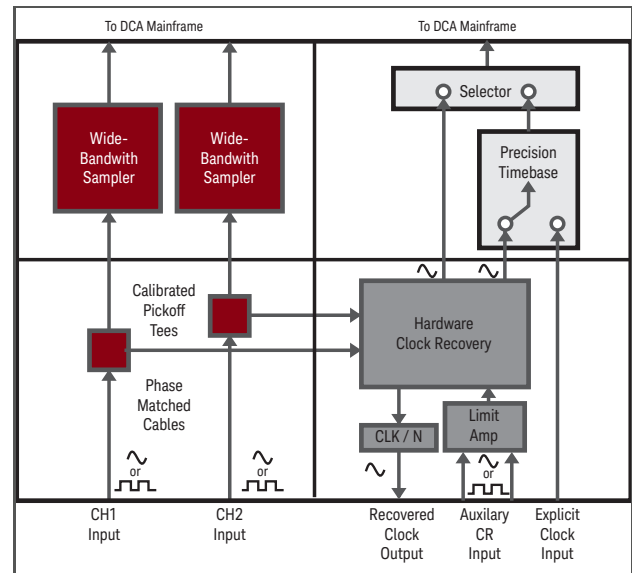

This combination results in the world's most accurate scope measurements available today. With setup similar to a real-time scope, it also provides significant ease-of-use advantages over traditional sampling scopes. The architecture virtually eliminates the trigger-sample delay inherent in most sampling instruments, and permits accurate and compliant measurement of large amounts of periodic jitter (e.g. SSC) without the use of specially matched cables which degrade performance.

PLL bandwidth, jitter transfer and jitter spectrum

The on-board phase detector of the 86108B allows for a precision measurement of phase-locked loop (PLL) bandwidth, sometimes referred to as jitter transfer. An external software application running on a PC controls the jitter source to provide a modulated stimulus to the device under test (DUT). The system is approved by the PCI SIG for PLL bandwidth compliance testing. The fast and flexible measurement can also test SONET/SDH and other PLL designs.



The Keysight B2900A Series of Precision Source/Measure Units are compact and cost-effective bench-top Source/Measure Units (SMUs) with the capability to output and measure both voltage and current. An SMU combines the capabilities of a current source, a voltage source, current meter and a voltage meter along with the capability to switch easily between these various functions into a single instrument.

### Best-in-class performance

The Keysight B2900A series of SMUs provide best-in-class performance at a lower price than ever before. They have broad voltage (210 V) and current (3 A DC and 10.5 A pulsed) sourcing capability, excellent precision (minimum 10 fA/100 nV sourcing and measuring resolution) and high measurement throughput. In addition, the Keysight B2900A series possess a superior graphical user interface with various viewing modes that dramatically improve test productivity, debug and characterization. The versatile integrated source and measurement capabilities of the Keysight B2900 series SMUs make them an ideal choice for testing semiconductors, active/passive components and a variety of other devices and materials.

### Four models

The Keysight B2900A series consists of four models, the B2901A, B2902A, B2911A and B2912A, differentiated through their available features (number of digits displayed, measurement resolution, minimum timing interval, supported viewing modes, etc.) and by the number of SMU channels (one or two) they contain. This makes it easy to select the exact price/performance point to meet your testing needs.

### Broad application range

The B2900 series has a broad application range that spans from R&D and education uses to industrial development, test and manufacturing. Moreover, they work equally well as either standalone or system components.

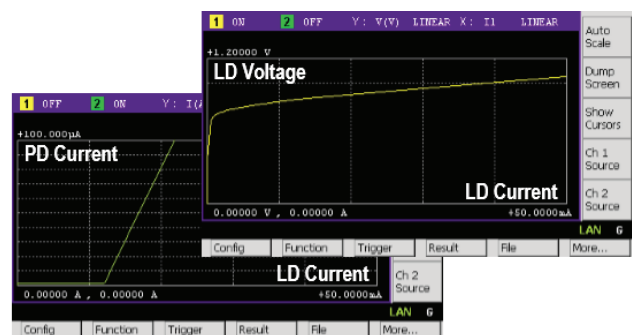

## Key features & Specifications

### Measurement capabilities

- Supports one-channel (B2901A and B2911A) and two-channel (B2902A and B2912A) configurations
- Minimum source resolution: 10 fA/100 nV, minimum measurement resolution: 10 fA/100 nV (B2911A and B2912A)
- Minimum source resolution: 1 pA / 1  $\mu$ V, minimum measurement resolution: 100 fA/100 nV (B2901A and B2902A)
- Maximum output: 210 V, 3 A DC/10.5 A pulse
- Digitizing capabilities from 10  $\mu$ s (B2911A and B2912A) and 20  $\mu$ s (B2901A and B2902A) interval

### General features

- Integrated 4-quadrant source and measurement capabilities
- The 4.3" color display supports both graphical and numerical view modes
- Free application software to facilitate PC-based instrument control
- High throughput and SCPI command supporting conventional SMU command set





The B2961A/B2962A is a revolutionary power supply for precision low noise voltage/current sourcing that features 6.5 digit, 100 nV/10 fA resolution, 10  $\mu$ Vrms noise, bipolar 210 V/3 A (10.5 A pulse) range, innovative sourcing functions, and GUI (Graphical User Interface)

**The world's only 6.5 digit source with a bipolar range of 100 nV to 210 V and 10 fA to 10.5 A**

The Keysight B2961A/B2962A Power Source has broad voltage (up to  $\pm 210$  V) and current (up to  $\pm 3$  A DC and  $\pm 10.5$  A pulsed) sourcing ranges and excellent 6.5 digit resolution (minimum 100 nV/10 fA program resolution). Unlike a typical power supply/source, it supports 4-quadrant operation that gives you the freedom to accurately and precisely supply any voltage or current contained within its ranges regardless of polarity.

**Noise floor of 10  $\mu$ Vrms (1 nVrms / $\sqrt{\text{Hz}}$  @ 10 kHz) outperforms even linear power supplies**

Low noise performance is required for the development of noise sensitive devices such as VCOs (voltage controlled oscillators), ADC/DAC, new material based components, etc. However, conventional power supplies and sources have not been able to achieve the noise level required for these applications. The Keysight B2961A/B2962A supports an optional external low noise filter that enables ultra-low noise performance down to 10  $\mu$ Vrms and 1 nVrms/ $\sqrt{\text{Hz}}$  (at 10 kHz), providing unparalleled low noise performance in a low-cost bench-top power source.

**Innovative sourcing capabilities enable test and evaluation not possible with conventional power supplies and sources**

The Keysight B2961A/B2962A supports a number of innovative sourcing capabilities for test and evaluation that are not available on conventional power supplies and sources. For example, the Keysight B2961A/B2962A has the ability to generate not only DC signals but also pulsed, swept and arbitrary waveforms

(1 mHz to 10 kHz) in both voltage and current. Its arbitrary waveform generation capability supports common waveform types such as sine, ramp, square, etc. in addition to user-defined waveforms.

The Keysight B2961A/B2962A also supports an advanced programmable output resistance feature that allows you to specify either a particular output resistance or a specific voltage versus current source characteristic. This feature is ideal for emulating a wide variety of devices that are otherwise difficult to simulate.

### General features

- Output voltage and current can be verified quickly using the built-in 4.5 digit voltage/current monitor
- Output voltage and current can be checked graphically on the 4.3" LCD front panel using the time-domain voltage/current waveform viewer
- Free PC application software for easy instrument control
- LXI Core conformant, USB2.0, GPIB, LAN and digital I/O interface

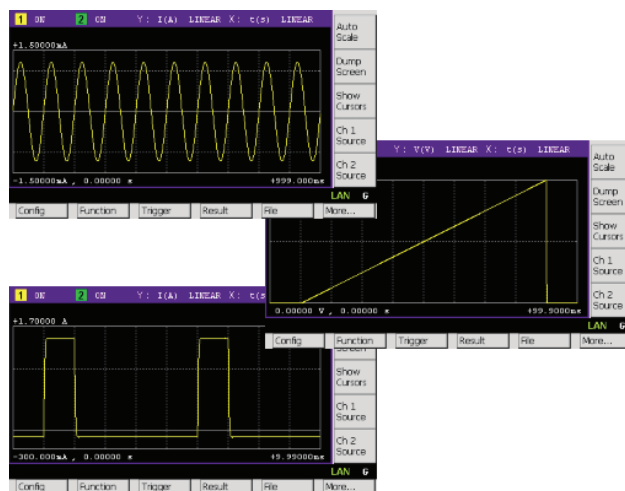

**Determine the operating characteristics of a laser diode**

The light-current-voltage (LIV) sweep test is a fundamental measurement to determine the operating characteristics of a laser diode (LD). In the LIV test, current applied to the laser diode is swept and the intensity of the resulting emitted light is measured using a photo detector (PD).

The Keysight Technologies, Inc. B2901/02/11/12A Precision Source/Measure Unit is a compact and cost-effective bench-top Source/Measure Unit (SMU) with the capability to output and measure both voltage and current. It covers currents from 10 fA to 3 A (DC)/10.5 A (pulse) and voltages from 100 nV to 210 V, which enables you to make a wide range of current versus voltage (IV) measurements more accurately and quickly than ever before.

**Get support from multiple free software control options**

In addition, the B2900A Series of SMUs comes with an intuitive graphical user interface (GUI) and multiple free software control options that make it easy for you to begin making productive measurements immediately, allowing you to choose the solution that best fits your particular application. These features make the B2900A Series of SMUs the best solution for LIV testing of laser diodes.

The B2902A and B2912A have two SMU channels, and each channel possesses accurate IV measurement capabilities as well as the ability to supply either constant or swept voltage/current. The B2902A and B2912A excellent choices for laser diode LIV testing.

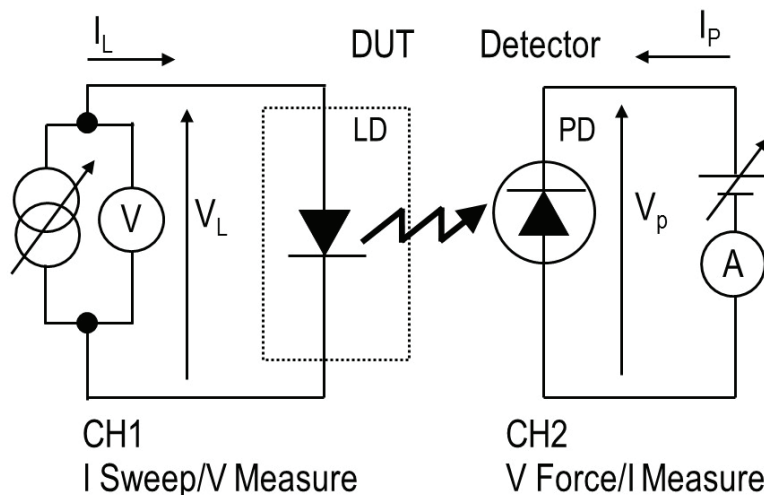
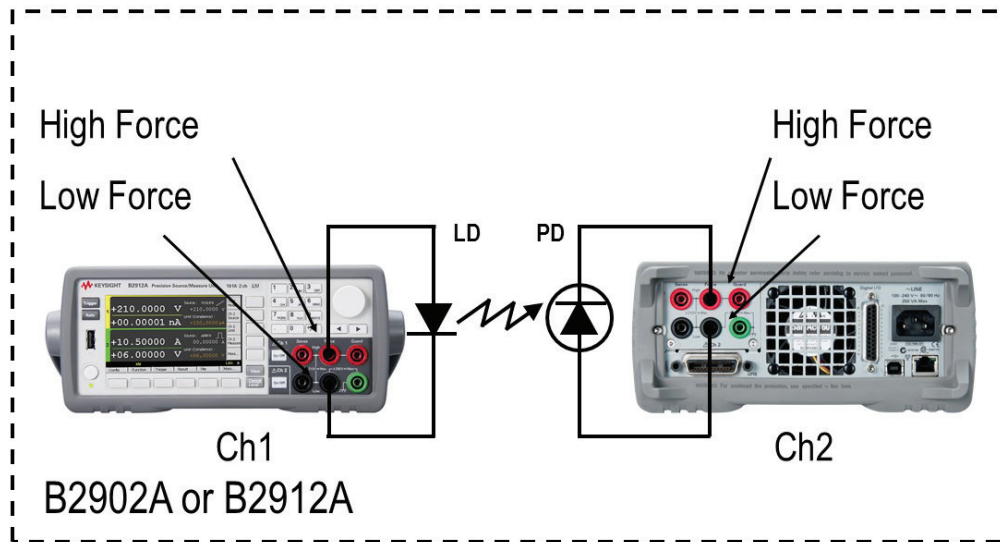

As shown in above using the B2902A or B2912A, you can easily measure the LIV characteristics of laser diodes, including tests such as a laser forward voltage, threshold voltage and slope efficiency.

In addition to its powerful and easy-to-use GUI, if you prefer PC-based instrument control, then the B2900A Series of SMUs comes with a range of free software control options to facilitate program development, allowing you to choose the solution that best fits your particular application.

## BenchVue

The Keysight BenchVue software for the PC reinvents your bench testing by making it simple to connect and record results with your instruments without the need for programming. You can quickly and easily obtain results by viewing, logging and exporting measurement data and screen images with just a few mouse clicks. BenchVue provides a wide array of capabilities, depending on the chosen instrument application. These capabilities will vary according to the functionality of the instrument types and models, including the B2900A Series of SMUs, that are connected to the PC that is running the BenchVue software. See <http://www.keysight.com/find/benchvue> for more details.



BenchVue

## Graphical Web Interface

The Keysight B2900A Graphical Web Interface provides functionality to allow access to the B2900A Series of SMUs over a LAN connection. The B2900A Series of SMUs is fully compliant with the LXI class C specification and contains a web server that provides a webpage with an interface to support the basic measurement functions of the B2900A. You can quickly and easily make measurements using a standard web browser by simply connecting the B2900A Series of SMUs to a PC using a LAN cable.

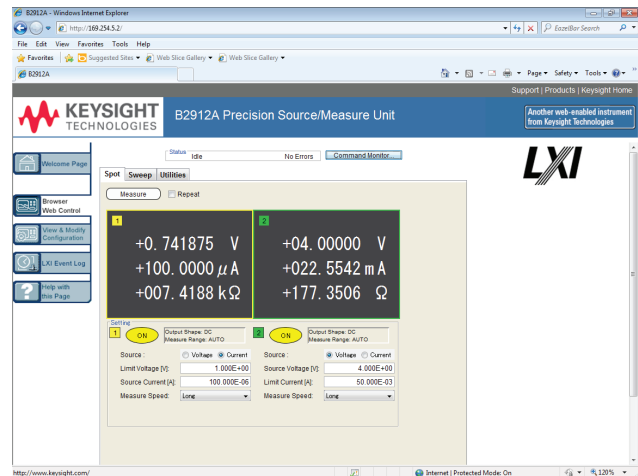

Graphical Web Interface

### Quick I/V Measurement Software

The Keysight B2900A Quick I/V Measurement Software is a common software solution for the entire B2900 precision instrument family. It has powerful measurement capabilities to control the B2900A Series of SMUs over GPIB, USB or LAN connections (see Figure 6).

You can download this PC-based software for free from <http://www.keysight.com/find/quickiv>.

The Keysight B2900A Quick I/V Measurement Software also supports a variety of functions such as a sweep measurement, a sampling measurement, basic math functions, graphical display functions and the ability to save test results as CSV files.

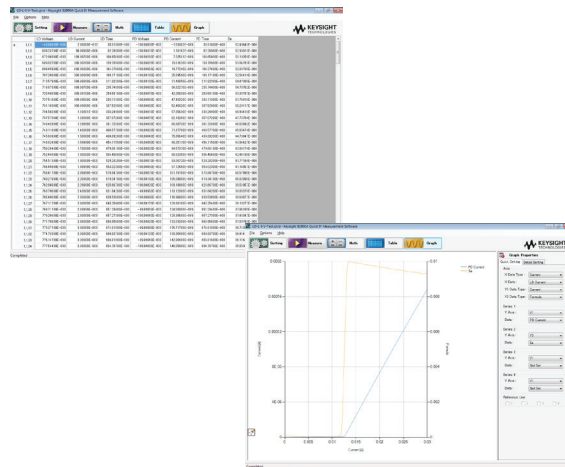
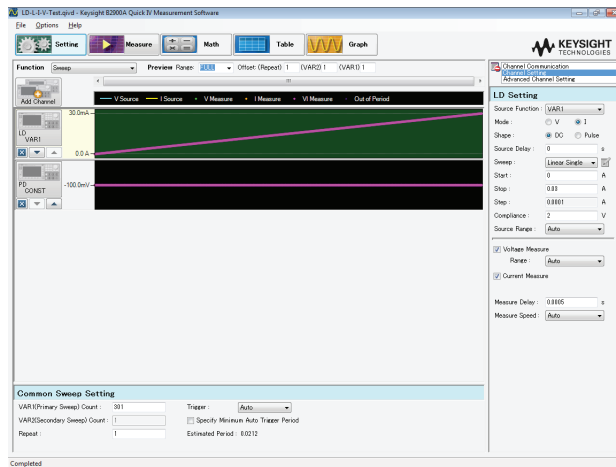

It is easy to make a quick measurement on a PC using the Keysight B2900A Quick I/V Measurement Software

### EasyEXPERT Group+

The EasyEXPERT group+ software is the more powerful solution for detailed characterization and analysis of devices, circuits and materials. It supports efficient and repeatable characterization across the entire characterization process from measurement setup and execution to analysis and data management.

EasyEXPERT group+ makes it easy to perform complex characterization with ready-to-use furnished measurements (application tests), and gives you the option of automatically storing every test condition and piece of measurement data in a unique built-in database (workspace), ensuring that valuable information is not lost and that measurements can be repeated at a later date.

See [www.keysight.com/find/easyexpert](http://www.keysight.com/find/easyexpert) for more details.

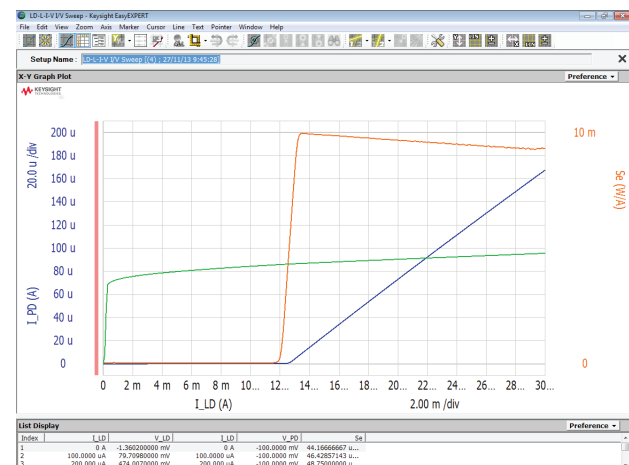
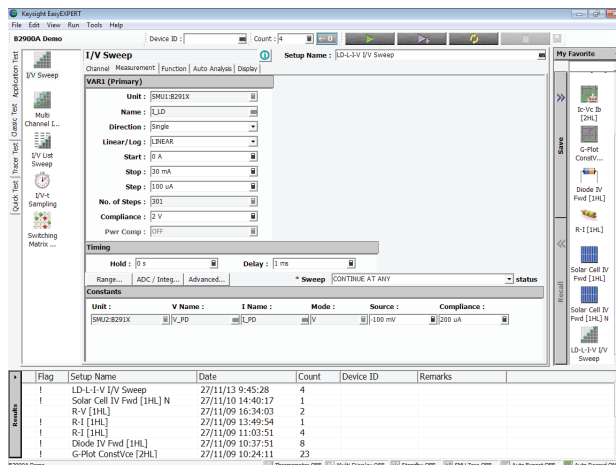

EasyEXPERT Group+ is a powerful solution for detailed characterization and analysis of devices, circuits and materials

**Threaded head adapter**

(Threaded adapter for 8152x Optical Heads, 8162x Optical Heads with 81624DD and 81628B Optical Heads)



81000FA FC/PC  
 81000KA SC  
 81000PA E-2000  
 81000VA ST  
 81003LA LC/F3000  
 FC/APC

**Optical head adapter**

These adapters are to be used with Keysight optical heads only. The connector adapters are needed to attach connecterized fibers.

Optical head adapters – with integral D-shape attachment for 8162xx optical head (except 81628B – see threaded version)



81001FA FC/PC  
 81001KA SC  
 81001PA E-2000  
 81001LA LC/F3000  
 81001MA MU

**81003TD - MPO/MTP connector adapter**

Optical head adapter with integral D-shape attachment for 8162xx optical head (except 81628B) for connection of ribbon cables with MT/ MPO connectors. The adapter has connector guide pins and should be used with female cable connectors.



**81001ZA - Blank adapter**

Plug-in D-shape adapter for 8162x Optical Heads To be customized by customer.

Doesn't match to 8152x and High Power Optical Heads



**81624DD - D-shape adapter**

To connect threaded adapters to 8162x D-shape receptable. Included with new heads except 81628B. Remove for using head with D-shaped adapters.



**Bare fiber adapters and interfaces**

The Keysight Bare Fiber Connectivity Solutions enable the easy and repeatable adaptation of optical components to Keysight's standard optical heads (all 8152x and 8162x series) and sensor modules 81630B, 81634B.



- 81000BC Bare fiber connectivity set for 81623B, 81624B and 81626B (1x head adapter, 1 x 0-400 um holder, 1 x 400-900 um holder, 1 x gauge)
- 81000BI Bare fiber connectivity Set for 81630B and 81634B (1 x sensor adapter, 1 x 0-400 um holder, 1 x 400-900 um holder, 1 x gauge)
- 81000BT Bare FC set for 8152x and 8162x optical heads and threaded interface
- 81004BH Bare fiber holder Set (10 x 0-400 um holder)
- 81009BH Bare fiber holder Set (10 x 400-900 um holder)
- 81004BM / 9BM Bare fiber holder Set (4 x 0-400 um or 0-900 um holder, 1 x gauge)

**N7740KI - SC**

4-port SC connector for the multiport power meter series N7744A and N7745A.



**N7740FI - FC**

4-port FC connector for the multiport power meter series N7744A and N7745A.



**N7740BI - Bare fiber adapter**

Fiber holders not included; please add 81004BM or 81009BM



**N7740ZI - Zeroing adapter**

**N7740LI - LC**

4-port LC connector for the multiport power meter series N7744A and N7745A.



**N7740MI - MU**

4-port MU connector for the multiport power meter series N7744A and N7745A.



**81000HI - E-2000 Connector interface**For **physical** contact connections

Recommended for angled and straight connector interfaces. Use with sources. Not for sensors.

**81000PI - E-2000 Connector interface**For **non-physical** contact connections

Recommended for angled and straight connector interfaces. Use with sensors.

**81000LI - LC/F3000 Connector interface**For **physical** contact connections

Recommended for angled and straight connector interfaces. Use with sources.A

**81002LI - LC/F3000 Connector interface**For **non-physical** contact connections

Recommended for angled and straight connector interfaces. Use with sensors.

**81000FI - FC/PC Connector interface**

N-keying (key slot = 2.20 mm nominal)

For physical and non-physical contact connections

Recommended for angled and straight connector interfaces

**81000NI - FC/APC Connector interface**

R-keying (key slot = 2.00 mm nominal)

For physical and non-physical contact connections

Recommended for angled and straight connector interfaces

**81000MI - MU Connector interface**For **physical** contact connections

Recommended for angled and straight connector interfaces. Use with sources.

**81002MI - MU Connector interface**For **non-physical** contact connections

Recommended for angled and straight connector interfaces. Use with sensors.

**81000KI - SC Connector interface**

For physical and non-physical contact connections

Recommended for angled and straight connector interfaces

**81000VI - ST Connector interface**

For physical and non-physical contact connections

Recommended for angled and straight connector interfaces

**81000SI - DIN 4108/47256 Connector interface**

For physical and non-physical contact connections

Recommended for angled and straight connector interfaces

**81000UM - Universal feedthrough adapter**

To adapt 81000BR or HMS-10 connectors to any other appropriate connector. In combination with a Keysight 81000xl connector interface, this adapter allows you to mate an HMS-10 connector to another HMS-10, FC/PC/SPC, APC, DIN, ST, E-2000, or SC connector. It can also be used to mate a Keysight 81000BR reference reflector to a connector under test. The Keysight 81000UM is a through adapter only. It can not be used at the fiber interfaces of the modules.

**81000BR - HMS-10 Reference reflector**

- Return loss = 0.18 dB  $\pm$  0.1 dB (96%  $\pm$  2%) typ.
- Wavelength range: 1200 to 1600 nm



A gold-plated HMS-10 connector for use in measuring return loss of optical connectors. It allows you to establish a precise reference for reflection measurements. Return loss is 0.18 dB  $\pm$  0.1 dB (96%  $\pm$  2%)

Keysight's universal optical interface is on the market for more than 25 years and allows users to adapt optical test instrumentation to a multitude of optical connector standards.

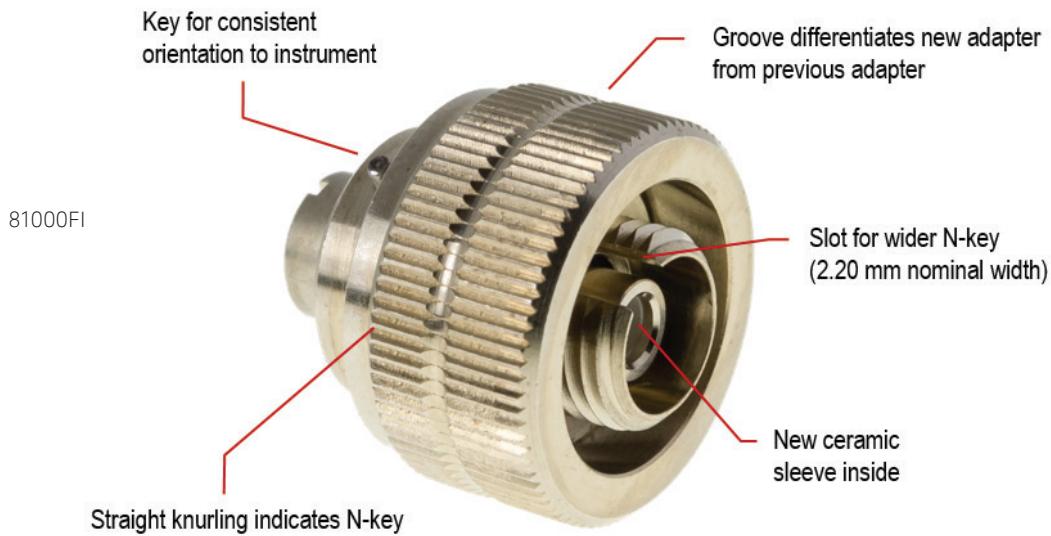

The new ceramic sleeve has been reinforced to combine robustness with greater precision and less wear. The most popular connector interfaces, used for FC/PC and FC/APC connectors, are now equipped with the new technology.

- A new ceramic sleeve centers the instrument's ferrule to the attached connector's ferrule, ensuring nearly wear-free and abrasion-free alignment.
- A groove on the knurled outer ring of the screw-on interface differentiates the new adapter from the current adapters that are equipped with a metal sleeve.
- Metallic sleeves have been considered the most abuse-forgiving alignment solution. However, metal surfaces inside the tube wear and leave contamination at the most critical place, the optical connector plane. Over time, metal sleeves open up enough to degrade the connection alignment.

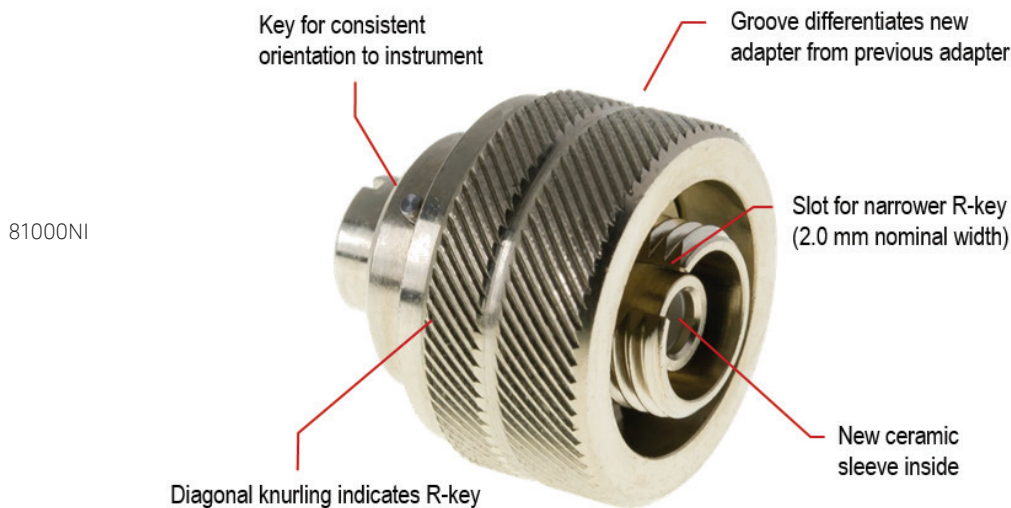

## Optical Power Meter Selection Table

[www.keysight.com/find/oct](http://www.keysight.com/find/oct)

Power meter heads	81623B	81623B C01/C85	81620B	81624B	81624B C01	81626B	81626B C01	81628B
Sensor element	Ge, ø 5 mm	Ge, ø 5 mm	Si, ø 5mm	InGaAs, ø 5mm	InGaAs, ø 5mm	InGaAs, ø 5mm	InGaAs, ø 5mm	InGaAs Sphere
Wavelength range [nm]	750 to 1800	750 to 1800	450 to 1020	800 to 1700	800 to 1700	850 to 1650	850 to 1650	800 to 1700
Power range [dBm]	-80 to +10	-80 to +10	-90 to +10	-90 to +10	-90 to +10	-70 to +27	-70 to +27	-60 to +40
Uncertainty at ref. cond.	±2.2%	±1.7% / ±2.2%	±2.2%	±2.2%	±1.5 %	±3.0 %	±2.5 %	±3.0 %
Rel. uncertainty due to polarization (typ.)	< ±0.005 dB	< ±0.005 dB		±0.002 dB	±0.002 dB	±0.002 dB	±0.002 dB	≤ ±0.006 dB
Rel. uncertainty spectral ripple (typ.)	< ±0.003 dB	< ±0.003 dB		≤ ±0.002 dB	≤ ±0.002 dB	≤ ±0.002 dB	≤ ±0.002 dB	≤ ±0.02 dB
Return loss (typ.)	> 55 dB	> 55 dB		60 dB	60 dB	> 45 dB	> 47 dB	> 75 dB
Averaging time (minimal)	100 µs	100 µs	100 µs	100 µs	100 µs	100 µs	100 µs	100 µs
Analog output	Yes	Yes	Yes	Yes	Yes	Yes	Yes	Yes

Power modules	81630B	81634B	81635A	81636B	N7744A	N7745A	N7747A	N7748A
Sensor element	InGaAs	InGaAs	InGaAs	InGaAs	InGaAs	InGaAs	InGaAs	InGaAs
No. of channels	1	1	2	1	4	8	2	4
Core diameter	Up to 100 µm	Up to 100 µm	Up to 62.5 µm	Up to 62.5 µm	≤ 62.5 µm	≤ 62.5 µm	Up to 100 µm	Up to 100 µm
Wavelength range [nm]	970 to 1650	800 to 1700	800 to 1650	1250 to 1640	1250 to 1650	1250 to 1650	800 to 1700	800 to 1700
Power range [dBm]	-70 to +28	-110 to +10	-80 to +10	-80 to +10	-80 to +10	-80 to +10	-110 to +10	-110 to +10
Uncertainty at ref. cond.	± 3.0%	± 2.5%	± 3.5%	± 3.0%	± 2.5%	± 2.5%	± 2.5%	± 2.5%
Rel. uncertainty due to polarization (dB)	< ± 0.01	< ± 0.005	Typ. < ± 0.015	Typ. ± 0.015	Typ. < ± 0.01 dB	Typ. < ± 0.01 dB	< ± 0.005	< ± 0.005
Rel. uncertainty spectral ripple (dB)	< ± 0.005	< ± 0.005	Typ. < ± 0.015	Typ. ± 0.015	Typ. < ± 0.01 dB	Typ. < ± 0.01 dB	< ± 0.005	< ± 0.005
Memory/channel (samples)	20 k	20 k	20 k	100 k	2 x 1 M	2 x 1 M	2 x 1 M	2 x 1 M
Averaging time (minimal)	100 µs	100 µs	100 µs	25 µs	1 µs	1 µs	100 µs	100 µs
Analog output	Yes	Yes	No	Yes	No	No	Yes	Yes



1240 nm	1360 nm	1460 nm	1530 nm	1565 nm	1625 nm	1675 nm
O-Band	E-Band	S-Band	C-Band	L-Band	U-Band	
<b>Compact, JET, iTLA-based</b>						
			81950A-310	81950A-310	81950A-301	
			N771xA-340	N771xA-340	N771xA-304	
<b>Full-size, ECL-based</b>						
					81606A-216, 81608A-216 (200 nm)	
					81606A/7A/8A -116 (150 nm)	
				81600B-140, 81600B-142		
	81602A-013					
	81606A-113, 81608A-113					



Device under test	Bit rate	Application examples	Typical requirements	Recommended Keysight BERT/AWG	
				For R&D Characterization, Compliance	For Manufacturing
High-speed serial receiver in computer buses and backplanes	< 16 G	QPI, PCI Express, SATA, SAS, USB3, TBT, DP, SD, UHS II, MIPI D-PHY/M-PHY, HDMI	data rates < 16 Gb/s, calibrated jitter, SSC, ISI and S.I., clock recovery, pattern sequencing	J-BERT M8020A M8030A	n/a
	< 10 G	MIPI D-PHY/ C-PHY HDMI, MHL	data rates < 10 G, no loopback, 3-wire or multi-level	M8190A, M8195A	n/a
Backplanes, Cables, SERDES, AOC, Repeaters	> 10 G to 28 G	10Gbase-KR4/-CR4, CEI, IB, TBT CAUI, CAUI 2/4 10Gbase-KR	data rates > 10 Gb/s, de-emphasis, x-talk, PRBS	J-BERT M8020A, M8062A, N4960A	n/a
	< 58 G	CEI-56G/112G, 400 GbE	PAM-4, NRZ, PRBS	M8040A	n/a
Optical transceivers and subcomponents: 0.6 to 58Gb/s	< 58 G	400 GbE, 64G FC	PAM-4, NRZ, PRBS	M8040A, M8196A	
	< 28 G	40 G/100 GbE, 32 G FC, CFP2/4	Data rates > 16 Gb/s clean signals, PRBS	N4960A, J-BERT M8020 + M8062A, N4917BSCA	N4960A
	10 G	10 G/40 GbE, PON, OTN, 8 G/16 G FC, QSFP, SFP+, QFP	Data rates 3 to 15 Gb/s, PRBS optical stress and sensitivity, framed bursts	J-BERT M8020A, M8030A	

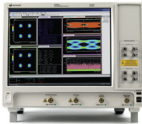

# Keysight Optical Modulation Analyzer Selection Table

[www.keysight.com/find/oma](http://www.keysight.com/find/oma)

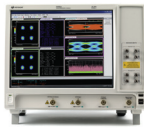
Performance Characteristic	M8292A	N4392A-300/320	N4391A (Z33   Z64)
			
Max. detectable symbol rate	74 GBd	46 GBd	66 GBd   125 GBd
Sample rate	83 GSa/s – 92 GSa/s	63 GSa/s	80 GSa/s   160 GSa/s
Max. record length per channel	512 kSa	16 kSa	Up to 2 GSa
ADC Resolution	8 bit	8 bit	8 bit
Analog Bandwidth (3 dB)	37 GHz	23 GHz	33 GHz   63 GHz
Operating Frequency Range	1 MHz – 40 GHz	50 kHz – 30 GHz	DC – 33 GHz   DC – 63 GHz
Relative skew after correction	< ±1 ps	< ±1 ps	< ±1 ps
EVM noise floor	< 2.4%	< 2.4%	< 1.8%
Sensitivity	- 20 dBm	- 22 dBm	- 20 dBm
Weight	20 kg (44 lbs)	13 kg (29 lbs)	48 kg (106 lbs)   96 kg (212 lbs)
Software platform		VSA/OMA 5.x	

Performance Characteristic	M8296A	N4392A-310	Infiniium Z Series
			
Signal input	Differential	Differential	Single ended
Number of channels	4	4	4   2
Sample rate	83 GSa/s – 92 GSa/s	63 GSa/s	80 GSa/s   160 GSa/s
Max. record length per channel	512 kSa <sup>1</sup>	16 kSa	Up to 2 GSa
ADC resolution	8 bit	8 bit	8 bit
Analog bandwidth (3 dB)	37 GHz	23 GHz	33 GHz   63 GHz
Operating Frequency Range <sup>2</sup>	50 kHz – 42 GHz	50 kHz – 31 GHz	DC – 33 GHz   DC – 63 GHz
Skew betw. different input ch	< ± 250 fs	< ± 2 ps	
RMS noise floor	.6 mV <sub>rms</sub> at 300 mV <sub>FS</sub> 9.5 mV <sub>rms</sub> at 800 mV <sub>FS</sub>		3.3 mV <sub>rms</sub> at 400 mV <sub>FS</sub> 6.4 mV <sub>rms</sub> at 800 mV <sub>FS</sub>
Weight	14 kg (31 lbs)	13 kg (29 lbs)	32 kg (71 lbs)
Software platform		VSA/OMA 5.x	

## Infiniium V-Series Oscilloscopes Selection Table

[www.keysight.com/find/VSeries](http://www.keysight.com/find/VSeries)

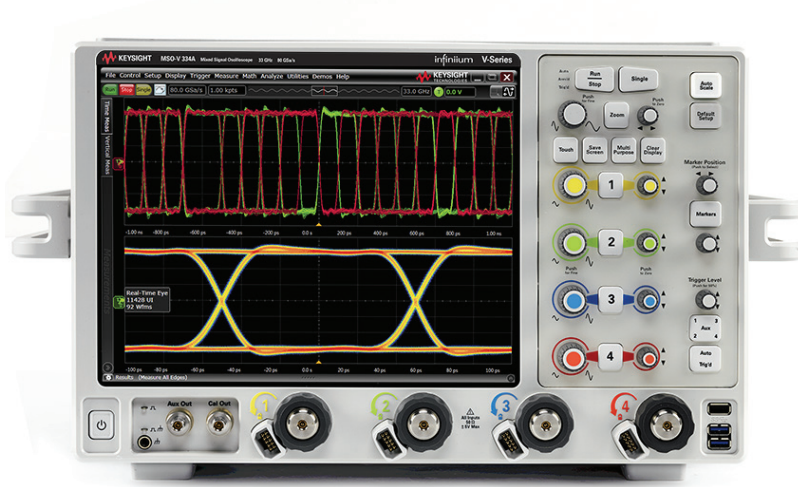

Infiniium V-Series' low-noise front end and the revolutionary voltage termination adapter provide the industry's best signal integrity.

DSO models	DSA models	MSO models	Analog bandwidth		Sample rate	
4 analog channels	4 analog channels	4 analog ch + 16 digital ch	2 channels	4 channels	2 channels	4 channels
DSOV334A	DSAV334A	MSOV334A	33 GHz	16 GHz	80 GSa/s	40 GSa/s
DSOV254A	DSAV254A	MSOV254A	25 GHz	16 GHz	80 GSa/s	40 GSa/s
DSOV204A	DSAV204A	MSOV204A	20 GHz	16 GHz	80 GSa/s	40 GSa/s
DSOV164A	DSAV164A	MSOV164A	16 GHz	16 GHz	80 GSa/s	40 GSa/s
DSOV134A	DSAV134A	MSOV134A	13 GHz	13 GHz	80 GSa/s	40 GSa/s
DSOV084A	DSAV084A	MSOV084A	8 GHz	8 GHz	80 GSa/s	40 GSa/s



## Evolving Since 1939

Our unique combination of hardware, software, services, and people can help you reach your next breakthrough. We are unlocking the future of technology.

From Hewlett-Packard to Agilent to Keysight.

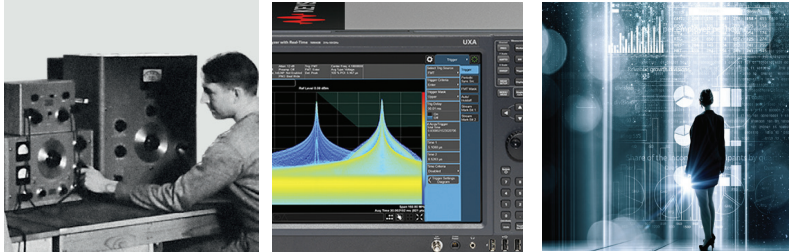

### myKeysight

#### myKeysight

[www.keysight.com/find/mykeysight](http://www.keysight.com/find/mykeysight)

A personalized view into the information most relevant to you.

[http://www.keysight.com/find/emt\\_product\\_registration](http://www.keysight.com/find/emt_product_registration)

Register your products to get up-to-date product information and find warranty information.

### KEYSIGHT SERVICES

Accelerate Technology Adoption.  
Lower costs.

#### Keysight Services

[www.keysight.com/find/service](http://www.keysight.com/find/service)

Keysight Services can help from acquisition to renewal across your instrument's lifecycle. Our comprehensive service offerings—one-stop calibration, repair, asset management, technology refresh, consulting, training and more—helps you improve product quality and lower costs.

#### Keysight Assurance Plans

[www.keysight.com/find/AssurancePlans](http://www.keysight.com/find/AssurancePlans)

Up to ten years of protection and no budgetary surprises to ensure your instruments are operating to specification, so you can rely on accurate measurements.

#### Keysight Channel Partners

[www.keysight.com/find/channelpartners](http://www.keysight.com/find/channelpartners)

Get the best of both worlds: Keysight's measurement expertise and product breadth, combined with channel partner convenience.

[www.keysight.com/find/lightwave](http://www.keysight.com/find/lightwave)

For more information on Keysight Technologies' products, applications or services, please contact your local Keysight office. The complete list is available at: [www.keysight.com/find/contactus](http://www.keysight.com/find/contactus)

#### Americas

Canada	(877) 894 4414
Brazil	55 11 3351 7010
Mexico	001 800 254 2440
United States	(800) 829 4444

#### Asia Pacific

Australia	1 800 629 485
China	800 810 0189
Hong Kong	800 938 693
India	1 800 11 2626
Japan	0120 (421) 345
Korea	080 769 0800
Malaysia	1 800 888 848
Singapore	1 800 375 8100
Taiwan	0800 047 866
Other AP Countries	(65) 6375 8100

#### Europe & Middle East

Austria	0800 001122
Belgium	0800 58580
Finland	0800 523252
France	0805 980333
Germany	0800 6270999
Ireland	1800 832700
Israel	1 809 343051
Italy	800 599100
Luxembourg	+32 800 58580
Netherlands	0800 0233200
Russia	8800 5009286
Spain	800 000154
Sweden	0200 882255
Switzerland	0800 805353
	Opt. 1 (DE)
	Opt. 2 (FR)
	Opt. 3 (IT)
United Kingdom	0800 0260637

For other unlisted countries:

[www.keysight.com/find/contactus](http://www.keysight.com/find/contactus)  
(BP-9-7-17)

DEKRA Certified  
ISO 9001 Quality Management System

[www.keysight.com/go/quality](http://www.keysight.com/go/quality)

Keysight Technologies, Inc.  
DEKRA Certified ISO 9001:2015  
Quality Management System

This information is subject to change without notice.

© Keysight Technologies, 2018  
Published in USA, March 8, 2018  
5989-6753EN

[www.keysight.com](http://www.keysight.com)

